

# ASSEMBLY INSTRUCTIONS

## FOR ADJUSTABLE FLAT PANEL WALL MOUNT

This product is designed to mount LCD TV weighing up to 30kg to wall.

**Safety Warning:** Be careful to make sure there are no missing or defective parts. Never use defective parts. Improper installation may cause damage or serious injury.

**Note:** The included hardware is for mounting on solid brick, concrete or hard wood batten/studs walls. If mounting on wood, do not use any concrete anchor. If you are uncertain about the nature of your wall, consult an expert. Please consult your hardware or installation professional for proper mounting to other types or walls. The supplied hardware is not for steel.

**Forbidden Instruction:** Do not mount onto plasterboard or paneled walls.

(A) M5x10 X4	(C) M6x10 X4	(E) Ø10x50 X6	(G) M8 X1	(I) M8 X2	(J) M8x20 X1
(B) M4x10 X4	(D) M6x60 X6	(F) M8x50 X1	(H) M8 X1	<b>SUPPLIED PARTS:</b> Supplied joint parts are exclusive for using in this product. Other joint parts are forbidden to use on this product. If any parts are missing or faulty, telephone the special franchiser for a placement.	

### 1 FIX TO WALL

**Note:** This product should be mounted to solid brick, concrete or hard wood batten/studs wall.

#### (a) SOLID BRICK AND CONCRETE BLOCK MOUNTING:

Use the wall plate as a template to mark 6 holes locations on the wall. Pre-Drill these holes with a 8mm masonry bit to at least 60mm in depth. Insert a Concrete Anchor (E) into each of these holes, Attach the wall Plate to the wall using 6 Lag bolts (D).

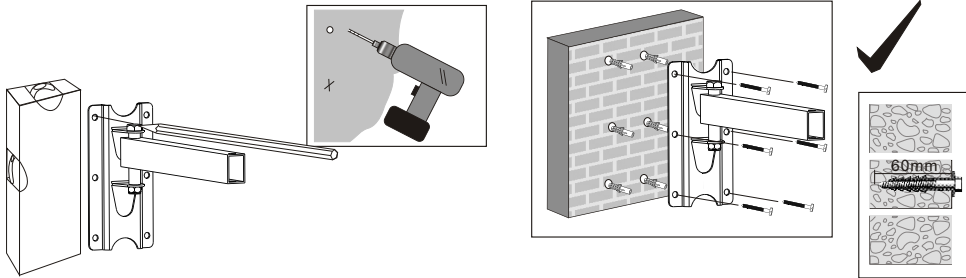

#### (b) HARD WOOD WALL MOUNTING:

Use the wall plate as a template to mark 6 holes locations on the wall. If the bracket mount onto wood studs wall, please use a high quality stud sensor to locate adjacent stud. It is a good idea to verify whether the holes you mark in the centre of the stud. Attach the wall Plate to the wall using for the 6 Lag Bolts (D).

**Note:** Do not use any concrete anchor when you mount the bracket onto hard wood wall.

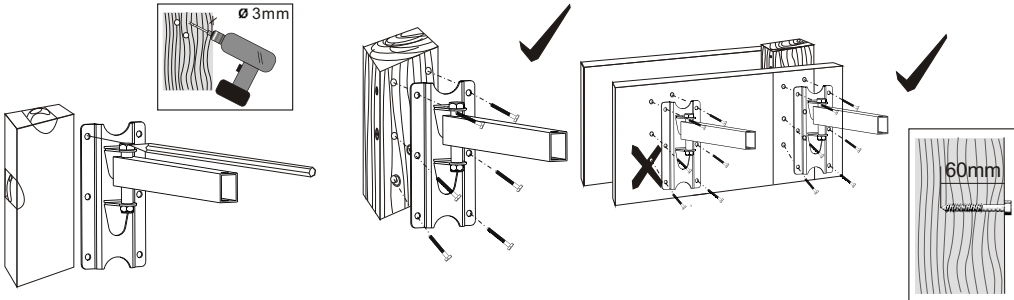

### 2 FIT SCREEN

2a

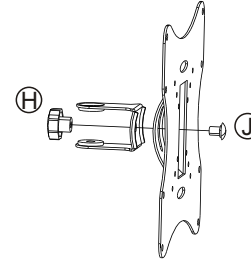

2c

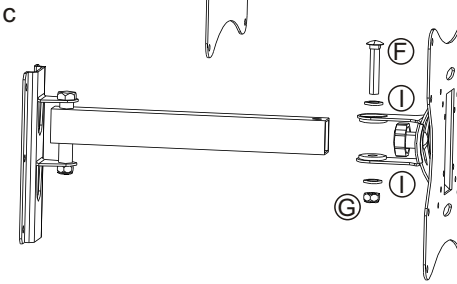

2b

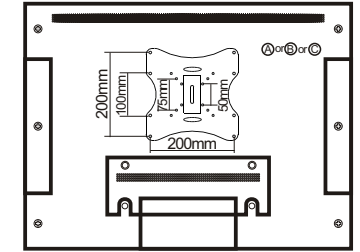

BACK VIEW OF LCD TV

Attach the LCD mount to the bracket using the four (A) or (B) or (C) screws provided.

### NOTE!

The standard fixing plate suits VESA 50mm, 75mm, 100mm, 200mm and 200x100mm fixing centres.

### 3 HIDE CABLES

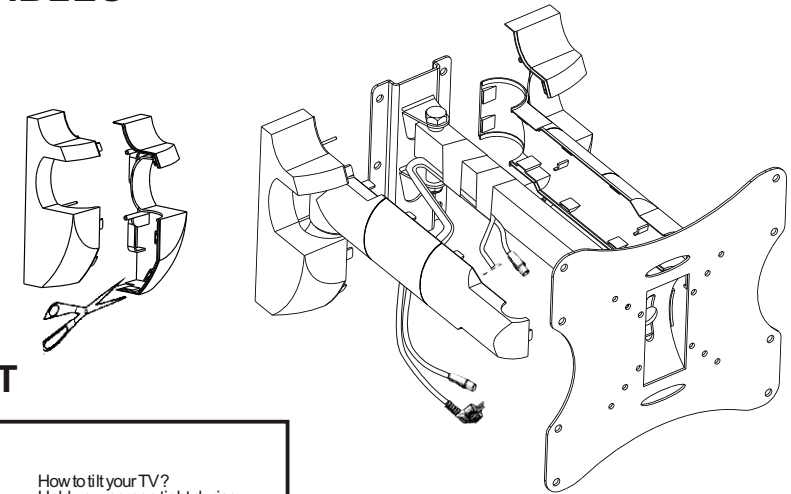

### 4 ADJUST

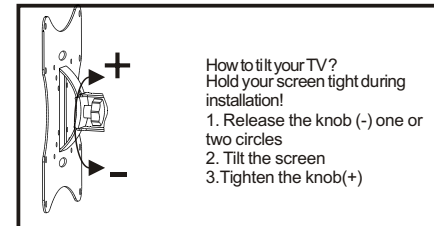

**CAUTION:** Do not exceed 30 kg weight limit

### TENDING INSTRUCTION

Please check whether screws are fixed well each two months.

IF YOU HAVE ANY DOUBTS REGARDING INSTALLATION CONSULT OUR SPECIAL FRANCHISER.