

























OŚWIETLENIE LED PRZEMYSŁOWE



Katalog produktów 2024

	ZASTLANIE CZ: NAPÁJENÍ SK: NAPÁJANIE EN: VOLTAGE
	MOC CZ: PŮIKON SK: PRÍKON EN: POWER
	TEMPERATURA KOLORU CZ: TEPLOTA CHROMATIČNOSTI SK TEPLOTA CHROMATIČNOSTI EN: COLOR TEMPERATURE
	WSPÓLCZYNNIK ODDAWANIA BARW CZ INDEX REPRODUKCE BAREV SK INDEX REPRODUKUCIE FARIEB EN: COLOR RENDERING INDEX
	ŚCIEMNIALNY CZ: STMÍVATELNÉ SK: STMIEVATELNÉ EN: DIMMABLE
	NIEŚCIEMNIALNY CZ: NESTMÍVATELNÉ SK: NIE JE STMIEVATELNÁ EN: NON DIMMABLE
	RODZAJ DIOD CZ: TYP LED SK: TYP LED EN: TYPE OF LEDS
	STRUMIEŃ ŚWIATLA CZ: SVĚTELNÍ TOK SK: SVĚTELNÍ TOK EN LUMINOUS FLUX
	KĄT ROZSYŁU ŚWIATŁA CZ: VYZAŘOVACÍ ÚHEL SK: VYZAŘOVACÍ ÚHOL EN ANGLES OF LIGHT DISTRIBUTION
PF	WSPÓLCZYNNIK MOCY CZ: FAKTOR SÍLY SK: ÚČINNÍK EN POWER FACTOR
	I KLASA OCHRONNOŚCI CZ I TRÍDA OCHRANY SK: I RIEDA OCHRANY EN: I APPLIANCE CLASS
	II KLASA OCHRONNOŚCI CZ II TRÍDA OCHRANY SK: II RIEDA OCHRANY EN: II APPLIANCE CLASS
	III KLASA OCHRONNOŚCI CZ: III TRÍDA OCHRANY SK: III RIEDA OCHRANY EN: III APPLIANCE CLASS
	NAZWA PRODUKTU CZ: NÁZEV VÝROBKU SK: NÁZOV VÝROBKU EN: NAME OF PRODUCT
	CZUJNIK RUCHU CZ: POHYBOVÝ SENZOR SK: POHYBOVÝ SENZOR EN MOTION SENSOR
	FUNKCJA KORYTARZOWA CZ: CHODBA FUNKCE SK FUNKCIA KORIDORU EN: CORRIDOR FUNCTION
	CZUJNIK ZMIERZCHOWY CZ: SÚMARKOVÉ ČIDLO SK: SOUMARKOVÉ ČIDLO EN: DUSK SENSOR
	KOD KRESKOWY CZ: ČÁROVÝ KÓD SK: ČIÁROVÝ KÓD EN BARCODE
	ZDJĘCIE CZ: FOTOGRAFIE SK: FOTOGRAFIE EN: PHOTOGRAPHY
	WYMIARY CZ: ROZMERY SK: ROZMERY EN: DIMENSIONS
	MATERIAŁ OBUDOWY CZ: MATERIÁL POUZDRA SK: MATERIÁL KRYTU EN: STUFF OF CASE
	KOLOR OBUDOWY CZ BARVA POUZDRA SK: FARIEB KRYTU EN: COLOUR OF CASE
	BRIDGELUX LED CZ: BRIDGELUX LED SK: BRIDGELUX LED EN: BRIDGELUX LED

	RODZAJ TRZONKA ŻARÓWKI CZ: TYP ZÁVITU ŽÁROVEK SK: TYP ZÁVITU ŽIAROVIEK EN: SHAFT TYPE OF BULBS
	NICHIA LED CZ: NICHIA LED SK: NICHIA LED EN: NICHIA LED
	PHILIPS LED CZ: PHILIPS LED SK: PHILIPS LED EN: PHILIPS LED
	SAMSUNG LED CZ: SAMSUNG LED SK: SAMSUNG LED EN: SAMSUNG LED
	CE CZ: CE SK: CE EN: CE
	ROHS CZ: ROHS SK: ROHS EN: ROHS
	PRODUKT DO UŽYTKU WEWNĘTRZNEGO CZ: K VNITRNÍMU POUŽITÍ SK: K VNÚTRONÉMU POUŽITIU EN: FOR INTERNAL USE
	PRODUKT DO UŽYTKU WEWNĘTRZNEGO I ZEWNĘTRZNEGO CZ: K VNITRNÍMU NEBO VENKOVNÍMU POUŽITÍ SK: K VNÚTRONÉMU ALEBO VONKAJŠIEMU POUŽITIU EN: FOR EXTERNAL AND INTERNAL USE
	STOPIEŃ SZCZELNOŚĆ CZ: STUPIEŃ KRYTÍ SK: STUPIEŃ KRYTA EN: LEAKPROOFNESS
	OKRES TRWAŁOŚCI CZ: ŽIVOTNOST SK: ŽIVOTNOST EN: SUSTAINABILITY
	TEMPERATURA UŻYTKOWANIA CZ: PRACOVNÍ TEPLOTA SK: PRACOVNÁ TEPLOTA EN: WORKING TEMPERATURE
	NAPIĘCIE WEJŚCIOWE CZ: VSTUPNÍ NAPĚTÍ SK: VSTUPNÉ NAPĚTIE EN: INPUT VOLTAGE
	NAPIĘCIE WYJŚCIOWE CZ: VÝSTUPNÍ NAPĚTÍ SK: VÝSTUPNÉ NAPĚTIE EN: OUTPUT VOLTAGE
	PRĄD WYJŚCIOWY CZ: VÝSTUPNÍ PROUD SK: VÝSTUPNÝ PRŮD EN: CURRENT OUTPUT
	NAPIĘCIE TĘTNIENÍ CZ: NAPĚTÍ ZVLNĚNÍ SK: NAPĚTIE ZVLNENIA EN: VOLTAGE RIPPLE
	DŁUGOŚĆ KABLA CZ: DĚLKA KABELU SK: DŁŻKA KÁBLA EN: CABLE LENGTH
	ZAKRES REGULACJI CZ: ROZSAH NASTAVENÍ SK: ROZSAH NASTAVENIA EN: ADJUSTMENT RANGE
	TOLERANCJA NAPIĘCIA CZ: TOLERANCE NAPĚTÍ SK: TOLERANCIA NAPĚTIA EN: VOLTAGE TOLERANCE
	LICZBA PRZYCISKÓW PILOTA CZ: POČET TLAČÍTEK DÁLKOVÉHO OVLÁDÁNÍ SK: POČET TLAČIDIEL DIALKOVÉHO OVLÁDANIA EN: NUMBER OF REMOTE CONTROL BUTTONS
	DŁUGOŚĆ TAŚMY RGB CZ: DĚLKA RGB TAPES SK: DŁŻKA RGB TAPES EN: LENGTH OF RGB TAPES
	CZĘSTOTLIWOŚĆ CZ: FREKVENCE SK: FREKVENCIA EN: FREQUENCY
	ZASIĘG PILOTA CZ: ŘÁDY DÁLKOVÉHO OVLÁDÁNÍ SK: DIALKOVÉ RIADENIE RIADENIA EN: REMOTE CONTROL RANGE

Lampy przemysłowe LED



JUNO str. 7-9



FOSEN str. 10



SACHI str. 11-12



SENTO str. 13



JERICO str. 14



MARGO str. 15



RAZO str. 16-17



ALCOTT str. 18-19



XYLIA str. 20



CANOPY str. 21



DRACO str. 22



RAMU str. 23



VELO str. 24



KARADAM str. 25

Lampy parkingowe LED



BAHIRA str. 27



SABRA str.28



LABID str. 29

Lampy parkowe



PARKOWE str.30



ADORA str.31

Dogruntowe



str. 32

Lampy uliczne LED



RAND str. 34



CADOG str. 35



ABLAR str. 36



GREEN str.37



HOLD str.38

Naświetlacze LED



CARLY str. 40



BAHIRA str. 41



MADOR str.42-43



PAXTON str. 44



GARAN str. 45



DORIN str. 46



BOLD str 47

Oprawy architektoniczne



FLOW str. 48-49



FREON str. 50



KREON str. 51



SURMUR str. 52



BRIK str. 53



BITEL str. 54



FERRA str. 55



LAMBO str. 56



RISSA str 57



RIVA str 58

Plafony LED



SPERE str. 60



SUNS str. 61-62



MARI str. 63



RIGBY str. 64



JARIN str. 65-66



JAREN str. 67-68

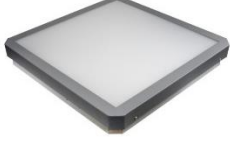

RAVA str. 69-70



VINGON str. 71



VITAL str. 72



VITALI str. 73



WILTON str. 74



KADER str. 75



NEGO str. 76



TUDOR str. 77

Downlighty LED



DAVELS str. 79-80



DINEL str. 81



ROWANA str. 82



GIMBAL str. 83



GRIPEN str. 84



SHINY str. 85



TILLY str. 86-87



XENA str. 88



KARIM str. 89



BOREM str. 90



KAREL str. 91



PERCI str. 92



TRIAD str. 93

Panele LED



TIMAN str. 95-107



KONAN str. 108-109



MALCOLM str. 110



KRIS str. 111-114



CLEAN str. 115



KRONOS str. 116



TRYTON str. 117

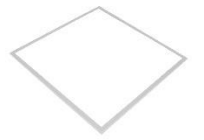

ZORDA str. 118

Oprawy LED



DREY str. 120-121



VOLTER str. 122-124



SIRMIUM str. 125



BRAY str. 126

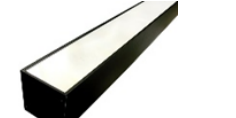

CABAIL str. 127-131



EDOM str. 132-133



REDOM str. 134

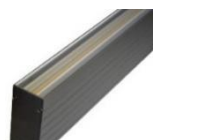

ALIA str. 135



LUNO str. 136



RONSE str. 137



FADIA str. 138



FELAN str. 139



OGIMA str. 140



HANAN str. 141



VILER str. 142



ERGON str. 143



EDULF str. 144

Oprawy świetłówkowe



ZASILANIE JEDNOSTRONE str. 145

Track lighty



BRENTLY str. 146-147



BRASCO str. 148



TRYCO str. 149



ROBIS str. 150



MORBIS str. 151



KARBIS str. 152



ORHAM str. 153

Szynoprzewody i akcesoria

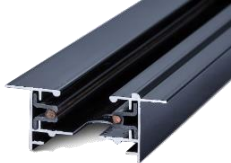

SZYNOPRZEWODY str. 154-156



AKCESORIA str. 157-158

Profile Basic

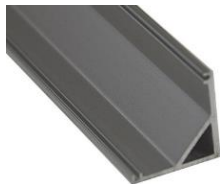

NAROŻNE str. 159



NAWIERZCHNIOWE str. 160



WPUSZCZANE str. 161

Profile Primal



NAWIERZCHNIOWE str. 162-163



WPUSZCZANE str. 164-165

Czujniki światła



ZMIERZCHOWE str. 166



0-10V str. 167

Oprawy awaryjne



STARLET NATYNKOWE str. 168



STARLET PODTYNKOWE str. 169



OWA str. 170



ORION str. 171



OXIMIA str. 172

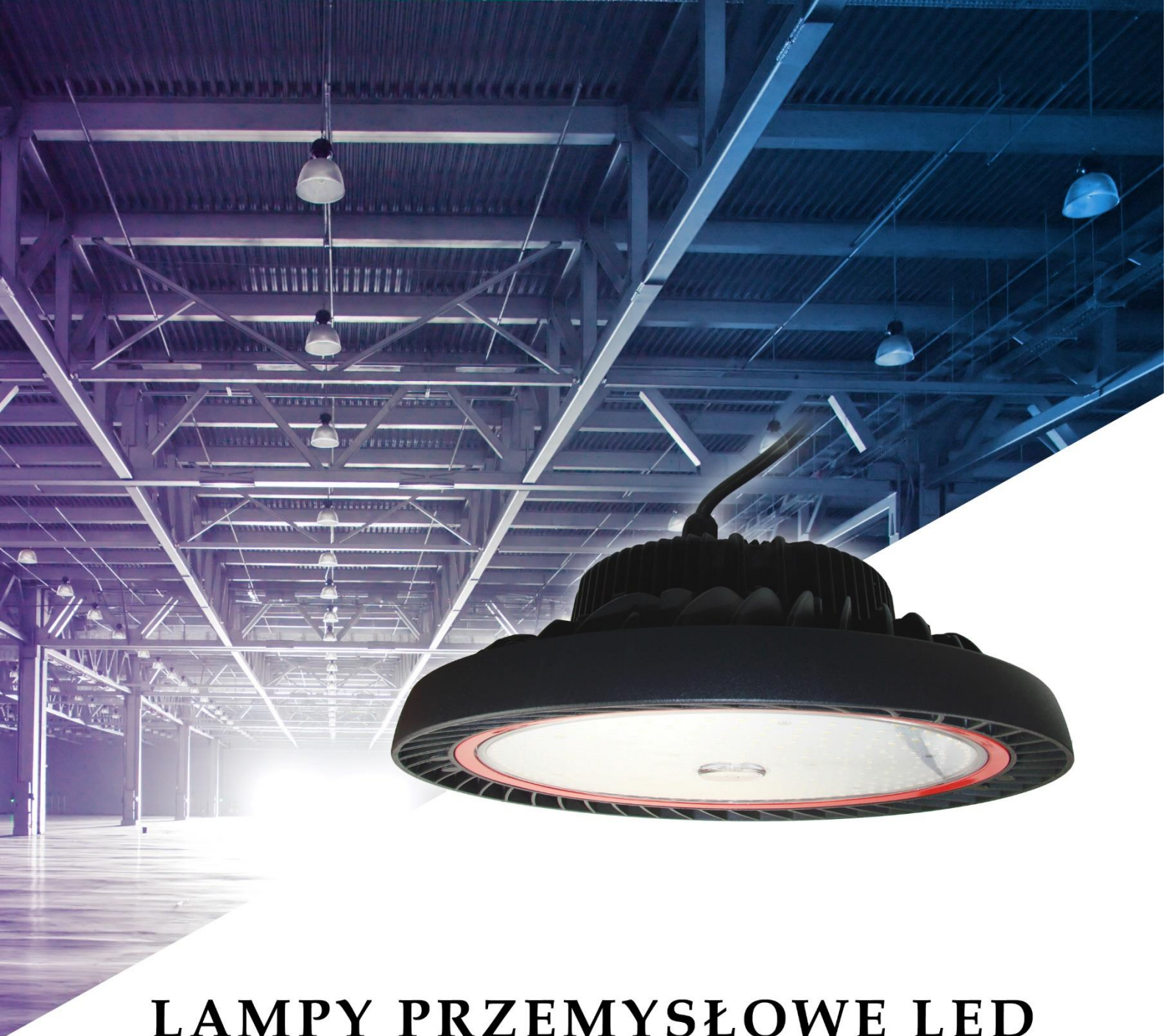

LAMPY PRZEMYSŁOWE LED

Lampy przemysłowe LED High bay służą do oświetlenia miejsc i placów o dużych powierzchniach: hal produkcyjnych, warsztatów, hal sportowych, hale wystawienniczych.

Dzięki zastosowaniu diod japońskiej marki **Nichia** o wysokiej efektywności oraz niezawodnych zasilaczy marki **Meanwell** lampy LED High bay będą działać stabilnie i bezawaryjnie co potwierdza **5-letnia gwarancja**.

Lampy LED Highbay są wyposażone w zasilacz z systemem **DALI** do sterowania ściemniania oświetlenia, dzięki czemu tryby

włączania/wyłączania i regulacji jasności można zaprogramować tak, aby jeszcze bardziej zoptymalizować działanie lamp.

Obudowa lampy wykonana jest ze stopu aluminium o wysokiej przewodności cieplnej, co gwarantuje dobre odprowadzanie ciepła i znacznie przedłuża czas eksploatacji.

HIGH BAY LED ŚCIEMIALNY 1-10V

CZ: Průmyslová svítidla LED HIGH BAY / SK: Priemyselná lampa / EN: LED high bay

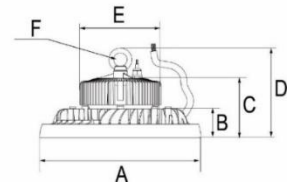
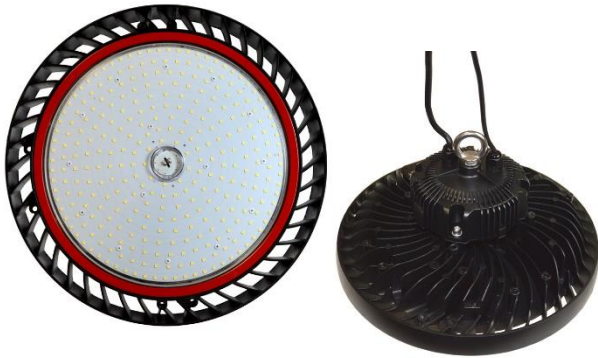

Tolerancja strumienia świetlnego +/- 10%
Średnia żywotność źródła światła L80B10 dla 70000h

INDEX	ABC				PF	Tc[K]		A [mm]	B [mm]	C [mm]	D [mm]	E [mm]	F [mm]	
012381	JUNO LED	100W	16 500 lm	165lm/W	0.95	4000 K	Czarny Černá Čierna Black	360	65	122	180	Ø124	Ø25	5902216796638
011471	JUNO LED	100W	16 500 lm	165lm/w	0.95	5700K		360	65	122	180	Ø124	Ø25	5902216729636
011800	JUNO LED	150W	23 250 lm	155lm/w	0.95	4000 K		360	65	122	180	Ø142	Ø25	5902216788206
006993	JUNO LED	150W	23 250 lm	155lm/w	0.95	5700K		360	65	122	180	Ø142	Ø25	5902216729612
011799	JUNO LED	200W	28 000 lm	140lm/w	0.95	4000 K		360	65	122	180	Ø166	Ø25	5902216788213
9304	JUNO LED	200W	28 000 lm	140lm/w	0.95	5700K		360	65	122	187	Ø166	Ø25	5902216729599
011577	JUNO LED	240W	31 200 lm	130lm/w	0.95	5700K		360	65	122	187	Ø166	Ø25	5902216773912

Dostępne Akcesoria:

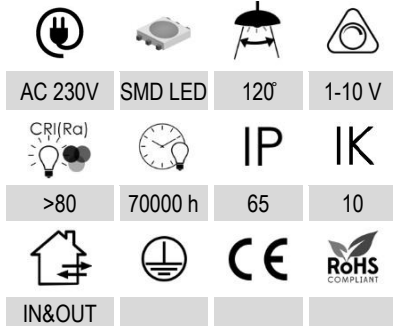

007115 Soczewka Lens 50°



010812 Soczewka Lens 90°



003745 Soczewka Lens 120°



006992 Soczewka Lens 150°



012130 Uchwyt do lampy LED high bay Juno I



012131 Uchwyt do lampy LED high bay Juno I

Materiał / Materiál / Materiál

PL: aluminium

CZ: hliník

SK: hliník

EN: aluminum

Optymalne warunki eksploatacji:

Optimální provozní podmínky:

Optimálne prevádzkové podmienky:

Optimal operating conditions:

PL: temperatura.: od -25°C do +60°C

wilgotność: <85% ciśnienie: 690-1060 hPa

CZ: teplota: od -25° C do +60° C

vlhkost: <85% tlak: 690-1060 hPa

SK: teplota: od -25° C do +60° C

vlhkosť: <85% tlak: 690-1060 hPa

EN: temperature: from -25° C to +60° C

humidity: <85% pressure: 690-1060 hPa

Uwagi / Komentář / Komentáre

PL: Zasilacz w komplecie

CZ: Napájení je součástí dodávky

SK: Napájanie je súčasťou dodávky

EN: Power supply included

JUNO DALI



HIGH BAY LED ŚCIEMNIALNY DALI

CZ: Průmyslová svítidla LED HIGH BAY stmívatelné / SK: Priemyselná lampa stmievateľné / EN: LED high bay dimmable



Driver

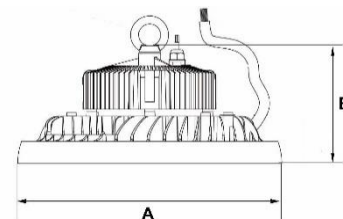
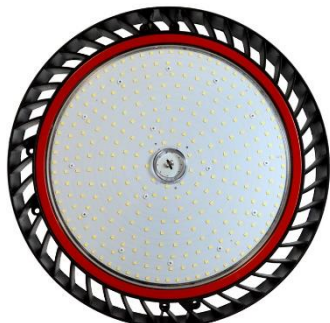

Średnia żywotność źródła światła L80B10 dla 70000h

INDEX	ABC				PF	Tc[K]		A [mm]	B [mm]	
012101	JUNO LED DALI	150W	23 250 lm	155lm/w	0.95	4000 K	Czarny Černá Čierna Black	360	187	5902216791060
012110	JUNO LED DALI	150W	23 250 lm	155lm/w	0.95	5700 K		360	180	5902216791503
012102	JUNO LED DALI	200W	30 000 lm	150lm/w	0.95	5700 K		360	187	5902216791077

AC 230V	SMD LED	120°	DALI
CRI/Ra	70000 h	IP	IK
>80	70000 h	65	10
IN&OUT	CE	ROHS COMPLIANT	

Dostępne Akcesoria:



007115 Soczewka Lens 50°



010812 Soczewka Lens 90°



003745 Soczewka Lens 120°



006992 Soczewka Lens 150°



012130 Uchwył do lampy LED high bay Juno I



012131 Uchwył do lampy LED high bay Juno I

Materiał / Materiál / Material

PL: aluminium

CZ: hliník

SK: hliník

EN: aluminum

Optymalne warunki eksploatacji:

Optimální provozní podmínky:

Optimálne prevádzkové podmienky:

Optimal operating conditions:

PL: temperatura.: od -25°C do +60°C

wilgotność: <85% ciśnienie: 690-1060 hPa

CZ: teplota: od -25 ° C do + 60 ° C

vlhkost: <85% tlak: 690-1060 hPa

SK: teplota: od -25 ° C do + 60 ° C

vlhkosť: <85% tlak: 690-1060 hPa

EN: temperature: from -25 ° C to + 60 ° C

humidity: <85% pressure: 690-1060 hPa

Uwagi / Komentář / Komentáre

PL: Zasilacz w komplecie

CZ: Napájení je součástí dodávky

SK: Napájanie je súčasťou dodávky

EN: Power supply included



JUNO PREMIUM



HIGH BAY LED ŚCIEMNIALNY 0-10V

CZ: Průmyslová svítidla LED HIGH BAY stmívatelné / SK: Priemyselná lampa stmievateľné / EN: LED high bay dimmable

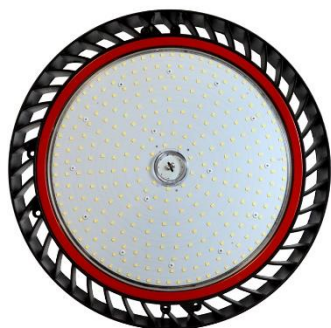

NICHIA
LED

Driver

MODEL:
MW HBG
MEAN WELL

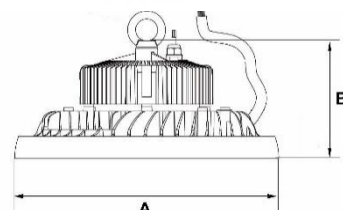

Średnia żywotność źródła światła L80B10 dla 70000h

INDEX	ABC				PF	Tc[K]		A [mm]	B [mm]	
012818	JUNO LED	100W	20 000 lm	200lm/W	0.95	5000 K	Czarny Černá Čierna Black	360	187	5902216797536

AC 230V	SMD LED	120°	0-10V
CRi(Ra)	70000 h	IP 65	IK 10
IN&OUT			

Dostępne Akcesoria:



007115 Soczewka Lens 50°



010812 Soczewka Lens 90°



003745 Soczewka Lens 120°



006992 Soczewka Lens 150°



012130 Uchwyt do lampy LED high bay Juno I



012131 Uchwyt do lampy LED high bay Juno I

Materiał / Materiál / Material

PL: aluminium

CZ: hliník

SK: hliník

EN: aluminum

Optymalne warunki eksploatacji:

Optimální provozní podmínky:

Optimálne prevádzkové podmienky:

Optimal operating conditions:

PL: temperatura.: od -25°C do +60°C

wilgotność: <85% ciśnienie: 690-1060 hPa

CZ: teplota: od -25 °C do + 60 °C

vlhkost: <85% tlak: 690-1060 hPa

SK: teplota: od -25 °C do + 60 °C

vlhkost: <85% tlak: 690-1060 hPa

EN: temperature: from -25 °C to + 60 °C

humidity: <85% pressure: 690-1060 hPa

Uwagi / Komentář / Komentáre

PL: Zasilacz w komplecie

CZ: Napájení je součástí dodávky

SK: Napájanie je súčasťou dodávky

EN: Power supply included

Br^olux

FOSEN



HIGH BAY LED

CZ: Průmyslová svítidla LED HIGH BAY / SK: Priemyselná lampa / EN: LED high bay

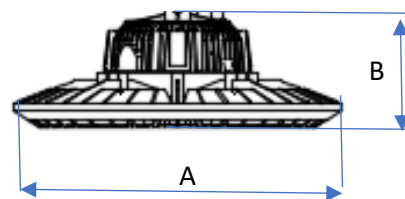

INDEX	ABC				PF	Tc[K]		A [mm]	B [mm]	
013503	FOSEN LED	100 W	17 000 lm	170lm/W	0.95	4000 K		300	110	5902808803195
013504	FOSEN LED	150 W	25 500 lm	170lm/W	0.95	4000 K		350	120	5902808803201
013505	FOSEN LED	200 W	34 000 lm	170lm/W	0.95	4000 K		400	120	5902808803218

AC 230V	SMD LED	90°	1-10 V
70	70000 h	65	10

Uwagi / Komentář / Komentáre

PL: Zasilacz w komplecie

CZ: Napájení je součástí dodávky

SK: Napájanie je súčasťou dodávky

EN: Power supply included

Materiál / Material / Material

PL: aluminium

CZ: hliník

SK: hliník

EN: aluminum

Optymalne warunki eksploatacji:

Optimální provozní podmínky:

Optimálne prevádzkové podmienky:

Optimal operating conditions:

PL: temperatura: od -25°C do +60°C

wilgotność: <85% ciśnienie: 690-1060 hPa

CZ: teplota: od -25 ° C do + 60 ° C

vlhkost: <85% tlak: 690-1060 hPa

SK: teplota: od -25 ° C do + 60 ° C

vlhkost: <85% tlak: 690-1060 hPa

EN: temperature: from -25 ° C to + 60 ° C

humidity: <85% pressure: 690-1060 hPa



SACHI

HIGH BAY LED



CZ: Průmyslová svítidla LED HIGH BAY / SK: Priemyselná lampa / EN: LED high bay



Driver

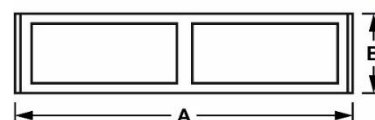
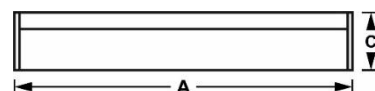

Średnia żywotność źródła światła L80B10 dla 70000h

	INDEX	ABC	⚡	💡 Lm	⚙️	💡 Lm	☂️	Tc[K]	📐	A [mm]	B [mm]	C [mm]	📊
A	011806	SACHI LED	100W	12 200 lm	-	122lm/W	30x70°	5000 K	📐	600	141	79	5902216788244
B	011807	SACHI LED	150W	15 860 lm	1-10V	122lm/W	30x70°	5000 K	📐	900	141	79	5902216788251

🔌	🏠	PF
AC 230V	SMD LED	IN&OUT
0.95		
💡	🕒	IP
CRI(Ra)		
>80	50000 h	65
CE	ROHS COMPLIANT	

Dostępne akcesoria:



011810 Soczewka Lens 80°



011809 Soczewka Lens 120°



012155 Uchwyt regulowany



012156 Uchwyt regulowany

Materiał / Materiál / Material

PL: aluminium

CZ: hliník

SK: hliník

EN: aluminum

Optymalne warunki eksploatacji:

Optimální provozní podmínky:

Optimálne prevádzkové podmienky:

Optimal operating conditions:

PL: temperatura.: od -25°C do +60°C

wilgotność: <85% ciśnienie: 690-1060 hPa

CZ: teplota: od -25°C do +60°C

vlhkost: <85% tlak: 690-1060 hPa

SK: teplota: od -25°C do +60°C

vlhkost: <85% tlak: 690-1060 hPa

EN: temperature: from -25°C to +60°C

humidity: <85% pressure: 690-1060 hPa

Uwagi / Komentář / Komentáre

PL: Zasilacz w komplecie

CZ: Napájení je součástí dodávky

SK: Napájanie je súčasťou dodávky

EN: Power supply included



SACHI DALI



HIGH BAY LED ŚCIEMNIALNY DALI

CZ: Průmyslová svítidla LED HIGH BAY / SK: Priemyselná lampa / EN: LED high bay



Driver

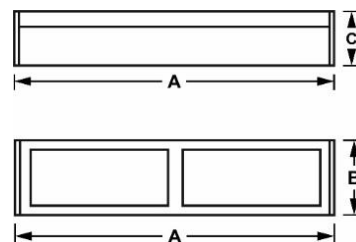

A

B

Średnia żywotność źródła światła L80B10 dla 70000h



INDEX



Lm



Lm



Tc[K]



A



B

C



0 123456789012

	INDEX	ABC	Power	Lm	Lm/W	Beam	Tc[K]	Color	A [mm]	B [mm]	C [mm]	Barcode
A	012117	SACHI LED	150W	15 860 lm	122lm/W	30x70°	5000 K	Czarny Černá Čierná Black	900	141	79	5902216791664
B	012118	SACHI LED	200W	26 000 lm	130lm/W	30x70°	5000 K	Czarny Černá Čierná Black	1200	141	79	5902216791671

Dostępne akcesoria:



AC 230V

SMD LED

IN&OUT

DALI



>80

50000 h

65

0.95



011810 Soczewk Lens 80°



011809 Soczewk Lens 120°



012155 Uchwyt regulowany



012156 Uchwyt regulowany

Materiał / Material / Material

PL: aluminium

CZ: hliník

SK: hliník

EN: aluminum

Optymalne warunki eksploatacji:

Optimální provozní podmínky:

Optimálne prevádzkové podmienky:

Optimal operating conditions:

PL: temperatura.: od -25°C do +60°C

wilgotność: <85% ciśnienie: 690-1060 hPa

CZ: teplota: od -25°C do +60°C

vlhkost: <85% tlak: 690-1060 hPa

SK: teplota: od -25°C do +60°C

vlhkost: <85% tlak: 690-1060 hPa

EN: temperature: from -25°C to + 60°C

humidity: <85% pressure: 690-1060 hPa

Uwagi / Komentář / Komentáre

PL: Zasilacz w komplecie

CZ: Napájení je součástí dodávky

SK: Napájanie je súčasťou dodávky

EN: Power supply included



SENTO



HIGH BAY LED

CZ: Průmyslová svítidla LED HIGH BAY / SK: Priemyselná lampa / EN: LED high bay



Driver
MW MEAN WELL
MODEL: **ELG**



A

B

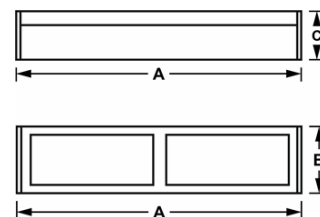

	INDEX	ABC		Lm	Lm		Tc[K]		A [mm]	B [mm]	C [mm]	
A	011804	SENTO LED	100 W	13 000 lm	130lm/W	30x70°	4000 K	Czarny Černá Čierná Black	600	141	79	5902216788220
B	011805	SENTO LED	150 W	18 000 lm	120lm/W	30x70°	4000 K		900	141	79	5902216788237
A	012066	SENTO LED	100 W	12 000 lm	120lm/W	30x70°	5500 K		600	141	79	5902216790995
B	012067	SENTO LED	150 W	18 000 lm	120lm/W	30x70°	5500 K		900	141	79	5902216791008

AC 230V	SMD LED	NON-DIM	IN&OUT
CR(Ra)	50000 h	IP	PF
>80	50000 h	65	0,95

Dostępne akcesoria:



011810 Soczewk Lens 80°



011809 Soczewk Lens 120°



012155 Uchwyt regulowany



012156 Uchwyt regulowany

Materiał / Materiál / Material

PL: aluminium

CZ: hliník

SK: hliník

EN: aluminum

Optymalne warunki eksploatacji:

Optimální provozní podmínky:

Optimálne prevádzkové podmienky:

Optimal operating conditions:

PL: temperatura.: od -25°C do +60°C

wilgotność: <85% ciśnienie: 690-1060 hPa

CZ: teplota: od -25°C do +60°C

vlhkost: <85% tlak: 690-1060 hPa

SK: teplota: od -25°C do +60°C

vlhkost: <85% tlak: 690-1060 hPa

EN: temperature: from -25°C to +60°C

humidity: <85% pressure: 690-1060 hPa

Uwagi / Komentář / Komentáre

PL: Zasilacz w komplecie

CZ: Napájení je součástí dodávky

SK: Napájanie je súčasťou dodávky

EN: Power supply included

Brulux

JERICO – AC LED



HIGH BAY LED

CZ: Průmyslová svítidla LED HIGH BAY / SK: Priemyselná lampa / EN: LED high bay

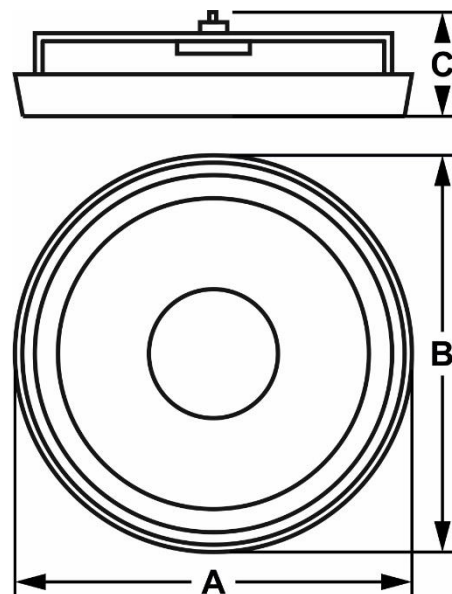

INDEX	ABC							A [mm]	B [mm]	C [mm]	
000272	JERICO LED	100 W	10 000 lm	100lm/W	60°	4500 K	Czarny	300	300	173	5902216725065
142	JERICO LED	150 W	15 000 lm	100lm/W	60°	4500 K	Černá	400	400	194	5902216725072
000314	JERICO LED	200 W	20 000 lm	100lm/W	60°	4500 K	Čierná Black	400	400	194	5902216725089

AC 230V	SMD LED	NON-DIM	IN&OUT
CRI(Ra)	IP	PF	
>70	50000 h	65	0,95
CE	RoHS COMPLIANT		

Materiał / Materiál / Material

PL: aluminium

CZ: hliník

SK: hliník

EN: aluminum

Optymalne warunki eksploatacji:

Optimální provozní podmínky:

Optimálne prevádzkové podmienky:

Optimal operating conditions:

PL: temperatura.: od -10°C do +25°C

wilgotność: <85% ciśnienie: 690-1060 hPa

CZ: teplota: od -10 ° C do + 25 ° C

vlhkost: <85% tlak: 690-1060 hPa

SK: teplota: od -10 ° C do + 25 ° C

vlhkost: <85% tlak: 690-1060 hPa

EN: temperature: from -10 ° C to + 25 ° C

humidity: <85% pressure: 690-1060 hPa

Br**l**ux

HIGH BAY LED ŚCIEMNIALNY 0-10V

CZ: Průmyslová svítidla LED HIGH BAY / SK: Priemyselná lampa / EN: LED high bay



NICHIA
LED

Driver
PHILIPS

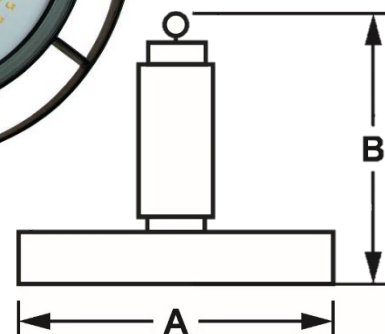

Średnia żywotność źródła światła L80B10 dla 70000h

INDEX	ABC →				Tc[K]		A [mm]	B [mm]	
011975	Margo LED	100 W	13 000 lm	130 lm/W	4500 K	Czarny Černá Čierna Black	312	275	5902216791084
008796	Margo LED	100 W	13 000 lm	130 lm/W	5700 K		320	278	5902216725362
011976	Margo LED	150 W	19 500 lm	130 lm/W	4500 K		320	275	5902216791091
008797	Margo LED	150 W	19 500 lm	130 lm/W	5700 K		320	278	5902216725379
012299	Margo LED	200 W	26 000 lm	130 lm/W	4500 K		400	355	5902216793880
008798	Margo LED	200 W	26 000 lm	130 lm/W	5700 K		400	355	5902216725386

AC 230V	SMD LED	120°	0-10V
CRI(Ra)	>80	50000 h	0,95
IN&OUT			

Materiał / Materiál / Material

PL: aluminium

CZ: hliník

SK: hliník

EN: aluminum

Optymalne warunki eksploatacji:

Optimální provozní podmínky:

Optimálne prevádzkové podmienky:

Optimal operating conditions:

PL: temperatura.: -25°C do +60°C

wilgotność: <85% ciśnienie: 690-1060 hPa

CZ: teplota: od -25°C do +60°C

vlhkost: <85% tlak: 690-1060 hPa

SK: teplota: od -25°C do +60°C

vlhkost: <85% tlak: 690-1060 hPa

EN: temperature: from -25°C to +60°C

humidity: <85% pressure: 690-1060 hPa

Uwagi / Komentář / Komentáre

PL: Zasilacz w komplecie

CZ: Napájení je součástí dodávky

SK: Napájanie je súčasťou dodávky

EN: Power supply included

HIGH BAY LED

CZ: Průmyslová svítidla LED HIGH BAY / SK: Priemyselná lampa / EN: LED high bay

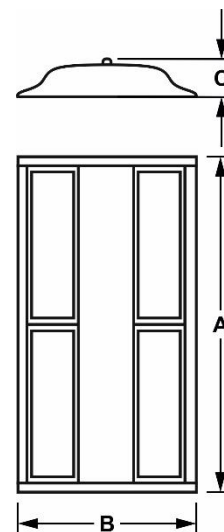

Średnia żywotność źródła światła L80B10 dla 70000h

	INDEX	ABC	Power	Lm	Lm/W	Tc [K]	Material	A [mm]	B [mm]	C [mm]	Barcode
A	012172	RAZO LED	100 W	14 000 lm	140lm/W	6000 K	Srebrny Stieborná stříbrná silver	300	307	66	5902216791688
A	012168	RAZO LED	150 W	21 000 lm	140lm/W	6000 K		300	307	66	5902216791701
A	012244	RAZO LED	200 W	28 000 lm	140lm/W	4000 K		580	307	66	5902216792685
A	012173	RAZO LED	200 W	28 000 lm	140lm/W	5500 K		580	307	66	5902216791718
A	012170	RAZO LED	300 W	42 000 lm	140lm/W	5500 K		880	307	66	5902216791732
B	012171	RAZO LED	400 W	56 000 lm	140lm/W	5500 K		1155	307	66	5902216791749

		PF	
AC 230V	SMD LED	0,95	IN&OUT
		IP	
>70	50000 h	65	90°

Materiał / Materiál / Material

PL: aluminium

CZ: hliník

SK: hliník

EN: aluminum

Optymalne warunki eksploatacji:

Optimální provozní podmínky:

Optimálne prevádzkové podmienky:

Optimal operating conditions:

PL: temperatura.: od -25°C do +60°C

wilgotność: <85% ciśnienie: 690-1060 hPa

CZ: teplota: od -25°C do +60°C

vlhkost: <85% tlak: 690-1060 hPa

SK: teplota: od -25°C do +60°C

vlhkost: <85% tlak: 690-1060 hPa

EN: temperature: from -25°C to +60°C

humidity: <85% pressure: 690-1060 hPa

Uwagi / Komentář / Komentáre

PL: Zasilacz w komplecie

CZ: Napájení je součástí dodávky

SK: Napájanie je súčasťou dodávky

EN: Power supply included



RAZO DALI



HIGH BAY LED ŚCIEMNIALNY DALI

CZ: Průmyslová svítidla LED HIGH BAY stmívatelné / SK: Priemyselná lampa stmievateľné / EN: LED high bay dimmable

PHILIPS
LED



Driver

MW MODEL:
MEAN WELL ELG

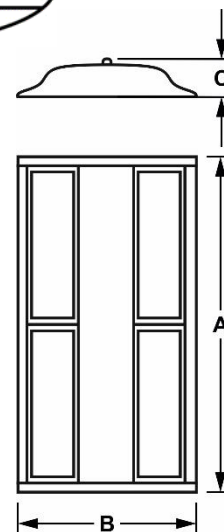

INDEX	ABC					Tc[K]		A [mm]	B [mm]	C [mm]	
012166	RAZO LED	100 W	14 000 lm	140lm/W	DALI	6000 K		300	307	66	5902216791695
012169	RAZO LED	200 W	28 000 lm	140lm/W	DALI	6000 K		580	307	66	5902216791725

AC 230V	SMD LED	120°	IN&OUT
CRI/Ra	50000 h	IP	PF
>70		65	0,95
CE	RoHS COMPLIANT		

Materiał / Materiál / Material

PL: aluminium

CZ: hliník

SK: hliník

EN: aluminum

Optymalne warunki eksploatacji:

Optimální provozní podmínky:

Optimálne prevádzkové podmienky:

Optimal operating conditions:

PL: temperatura: od -25°C do +60°C

wilgotność: <85% ciśnienie: 690-1060 hPa

CZ: teplota: od -25°C do +60°C

vlhkost: <85% tlak: 690-1060 hPa

SK: teplota: od -25°C do +60°C

vlhkost: <85% tlak: 690-1060 hPa

EN: temperature: from -25°C to +60°C

humidity: <85% pressure: 690-1060 hPa

Uwagi / Komentář / Komentáre

PL: Zasilacz w komplecie

CZ: Napájení je součástí dodávky

SK: Napájanie je súčasťou dodávky

EN: Power supply included

BroLux

www.bowi.com.pl

ALCOTT – AC LED



HIGH BAY LED

CZ: Průmyslová svítidla LED HIGH BAY / SK: Priemyselná lampa / EN: LED high bay



	INDEX	ABC				Tc[K]		A [mm]	B [mm]	C [mm]	
A	010576	Alcott LED	60W	6 600 lm	110 lm/W	4500 K	Srebrny Stieborná stříbrná silver	279	225	230	5902216710559
A	010562	Alcott LED	60W	6 600 lm	110 lm/W	5700 K		279	225	230	5902216719248
B	010574	Alcott LED	90W	9 900 lm	110 lm/W	5700 K		279	305	230	5902216710030
B	010608	Alcott LED	90W	9 900 lm	110 lm/W	4500 K		279	305	230	5902216719231
C	010616	Alcott LED	120W	13 200 lm	110 lm/W	4500 K		279	385	230	5902216710047
C	010529	Alcott LED	120W	13 200 lm	110 lm/W	5700 K		279	385	230	5902216701243
D	010617	Alcott LED	150W	16 500 lm	110 lm/W	4500 K		279	465	230	5902216710054
D	008955	Alcott LED	150W	16 500 lm	110 lm/W	5700 K		279	465	230	5902216701236

AC 230V	Power LED	60°	NON-DIM
≥70	40000 h	65	IN&OUT
≥0.95			

Materiał / Materiál / Material

PL: aluminium

CZ: hliník

SK: hliník

EN: aluminum

Optymalne warunki eksploatacji:

Optimální provozní podmínky:

Optimálne prevádzkové podmienky:

Optimal operating conditions:

PL: temperatura.: od -10°C do +25°C

wilgotność: <85% ciśnienie: 690-1060 hPa

CZ: teplota: od -10 ° C do + 25 ° C

vlhkost: <85% tlak: 690-1060 hPa

SK: teplota: od -10 ° C do + 25 ° C

vlhkost: <85% tlak: 690-1060 hPa

EN: temperature: from -10 ° C to + 25 ° C

humidity: <85% pressure: 690-1060 hPa

Brulux

HIGH BAY LED

CZ: Průmyslová svítidla LED HIGH BAY / SK: Priemyselná lampa / EN: LED high bay



A



B

	INDEX			W×H	
A	004974	Uchwyt do lampy High Bay Alcott	Srebrny Stieborná stříbrná silver	340x160mm	5902216710672
A	001115	Uchwyt do lampy High Bay Alcott		420x160mm	5902216710689
B	366	Uchwyt do lampy High Bay Alcott ruchomy		317x160mm	5902216713932
B	6657	Uchwyt do lampy High Bay Alcott ruchomy		396x160mm	5902216713949



Materiał / Materiál / Material

PL: aluminium

CZ: hliník

SK: hliník

EN: aluminum

XYLIA



HIGH BAY LED

CZ: Průmyslová svítidla LED HIGH BAY / SK: Priemyselná lampa / EN: LED high bay



Driver

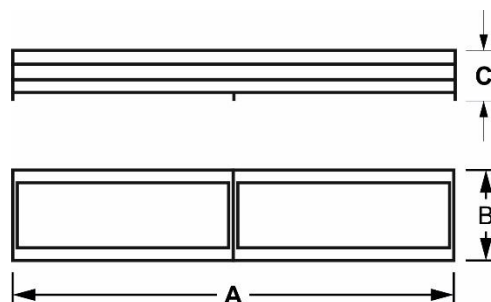

Średnia żywotność źródła światła L80B10 dla 70000h

INDEX	ABC				Tc[K]		A [mm]	B [mm]	C [mm]	
012208	XYLIA LED	150 W	21 000lm	140 lm/W	6500 K	Czarny Černá Čierná Black	644	178	110	5902216792142

AC 230V	SMD LED	60°	80
50000 h	65		>0,95

Materiał / Materiál / Material

PL: aluminium

CZ: hliník

SK: hliník

EN: aluminum

Optymalne warunki eksploatacji:

Optimální provozní podmínky:

Optimálne prevádzkové podmienky:

Optimal operating conditions:

PL: temperatura.: od -25°C do +60°C

wilgotność: <85% ciśnienie: 690-1060 hPa

CZ: teplota: od -25°C do +60°C

vlhkost: <85% tlak: 690-1060 hPa

SK: teplota: od -25°C do +60°C

vlhkost: <85% tlak: 690-1060 hPa

EN: temperature: from -25°C to +60°C

humidity: <85% pressure: 690-1060 hPa

Uwagi / Komentář / Komentáre

PL: Zasilacz w komplecie

CZ: Napájení je součástí dodávky

SK: Napájanie je súčasťou dodávky

EN: Power supply included



CANOPY



LAMPA LED DO STACJI PALIW

CZ: LED svítlna pro čerpací stanice / SK: LED lampa pre čerpacie stanice / EN: LED lamp for petrol stations

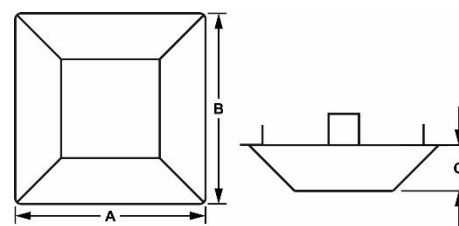

Średnia żywotność źródła światła L80B10 dla 70000h

INDEX	ABC						A [mm]	B [mm]	C [mm]	
012499	Canopy LED	100 W	14 000 lm	140lm/W	4500 K	Biały biła	382	382	48,5	5902216795945
012500	Canopy LED	150 W	21 300 lm	142lm/W	4500 K	Bielá white	382	382	48,5	5902216795952

AC 230V	SMD LED	120°	1-10V
CRI(Ra)		IP	
>80	40000 h	65	

Materiał / Materiál / Material

PL: aluminium

CZ: hliník

SK: hliník

EN: aluminum

Optymalne warunki eksploatacji:

Optimální provozní podmínky:

Optimálne prevádzkové podmienky:

Optimal operating conditions:

PL: temperatura.: od -25°C do +60°C

wilgotność: <85% ciśnienie: 690-1060 hPa

CZ: teplota: od -25°C do +60°C

vlhkost: <85% tlak: 690-1060 hPa

SK: teplota: od -25°C do +60°C

vlhkost: <85% tlak: 690-1060 hPa

EN: temperature: from -25°C do +60°C

humidity: <85% pressure: 690-1060 hPa

Uwagi / Komentář / Komentáre

PL: Zasilacz w komplecie

CZ: Napájení je součástí dodávky

SK: Napájanie je súčasťou dodávky

EN: Power supply included



DRACO



HIGH BAY LED

CZ: Průmyslová svítidla LED HIGH BAY / SK: Priemyselná lampa / EN: LED high bay



INVENTRONICS
LUMILEDS

INDEX	ABC				PF	Tc[K]		A [mm]	B [mm]	
013855	DRACO LED	100 W	19 000 lm	190 lm/W	0,95	4000 K	Czarny Černá Čierná Black	250	130	5902808807155
006715	DRACO LED	150 W	28 500 lm	190 lm/W	0.95	4000 K		295	140	5902808804185
013633	DRACO LED	200 W	38 000 lm	190 lm/W	0.95	4000 K		320	160	5902808804192

AC 230V	SMD LED	90°	IP	IK
>70	70000 h	65	10	
IN&OUT				

Materiał / Material / Material

PL: aluminium

CZ: hliník

SK: hliník

EN: aluminum

Optymalne warunki eksploatacji:

Optimální provozní podmínky:

Optimálne prevádzkové podmienky:

Optimal operating conditions:

PL: temperatura: od -25°C do +60°C

wilgotność: <85% ciśnienie: 690-1060 hPa

CZ: teplota: od -25 ° C do + 60 ° C

vlhkost: <85% tlak: 690-1060 hPa

SK: teplota: od -25 ° C do + 60 ° C

vlhkost: <85% tlak: 690-1060 hPa

EN: temperature: from -25 ° C to + 60 ° C

humidity: <85% pressure: 690-1060 hPa

Uwagi / Komentář / Komentáre

PL: Zasilacz w komplecie

CZ: Napájení je součástí dodávky

SK: Napájanie je súčasťou dodávky

EN: Power supply included

BroLux

RAMU



HIGH BAY LED

CZ: Průmyslová svítidla LED HIGH BAY / SK: Priemyselná lampa / EN: LED high bay



INDEX	ABC		Lm	Lm	PF	Tc[K]		A [mm]	B [mm]	
045369	RAMU LED	100 W	18 000 lm	180 lm/W	0,95	4000 K		295	140	5902808808893
045368	RAMU LED	150 W	27 000 lm	180 lm/W	0.95	4000 K		295	140	5902808808909
012333	RAMU LED	200 W	36 000 lm	180 lm/W	0.95	4000 K		320	154	5902216794054

AC 230V	SMD LED	90°	1-10V
CRi(Ra)	IP	IK	
>70	70000 h	65	10
IN&OUT			

Materiał / Materiál / Material

PL: aluminium

CZ: hliník

SK: hliník

EN: aluminum

Optymalne warunki eksploatacji:

Optimální provozní podmínky:

Optimálne prevádzkové podmienky:

Optimal operating conditions:

PL: temperatura: od -25°C do +60°C

wilgotność: <85% ciśnienie: 690-1060 hPa

CZ: teplota: od -25 ° C do + 60 ° C

vlhkost: <85% tlak: 690-1060 hPa

SK: teplota: od -25 ° C do + 60 ° C

vlhkost: <85% tlak: 690-1060 hPa

EN: temperature: from -25 ° C to + 60 ° C

humidity: <85% pressure: 690-1060 hPa

Uwagi / Komentář / Komentáre

PL: Zasilacz w komplecie

CZ: Napájení je součástí dodávky

SK: Napájanie je súčasťou dodávky

EN: Power supply included



VELO



HIGH BAY LED

CZ: Průmyslová svítidla LED HIGH BAY / SK: Priemyselná lampa / EN: LED high bay



INDEX	ABC				PF	Tc[K]			A [mm]	B [mm]	C [mm]	
008808	VELO LED	100 W	100lm/W	110°	0,95	4500 K	Aluminium Hliník Hliník aluminium	Czarny Černá Čierná Black	280	280	80	5902216725249
008807	VELO LED	150 W	100lm/W	110°	0,95	4500 K			330	330	86	5902216725256
008820	VELO LED	200 W	100lm/W	110°	0,95	4500 K			370	370	88	5902216725263

AC 230V	IN&OUT	NON-DIM
CRi(Ra)	IP	
>80	50000 h	65
		SMD LED

Uwagi / Komentář / Komentáře

PL: Zasilacz w komplecie

CZ: Napájení je součástí dodávky

SK: Napájanie je súčasťou dodávky

EN: Power supply included

Optymalne warunki eksploatacji:

Optimální provozní podmínky:

Optimálne prevádzkové podmienky:

Optimal operating conditions:

PL: temperatura.: od -10°C do +40°C

wilgotność: <85% ciśnienie: 690-1060 hPa

CZ: teplota: od -10° C do + 40°C

vlhkost: <85% tlak: 690-1060 hPa

SK: teplota: od -10° C do +40°C

vlhkost: <85% tlak: 690-1060 hPa

EN: temperature: from -10°C to + 40°C

humidity: <85% pressure: 690-1060 hPa

BroLux

KARADAM



HIGH BAY LED

CZ: Průmyslová svítidla LED HIGH BAY / SK: Priemyselná lampa / EN: LED high bay



INDEX	ABC				PF	Tc[K]		A [mm]	B [mm]	
045570	KARADAM LED	100 W	10 000 lm	100lm/W	0.9	4000 K	Czarny Černá Čierná Black	254	38	5902808809401
045571	KARADAM LED	150 W	15 000 lm	100lm/W	0.9	4000 K		354	38	5902808809418
045572	KARADAM LED	200 W	20 000 lm	100lm/W	0.9	4000 K		330	42	5902808809425

AC 230V	SMD LED	110°	NON-DIM
80	70000 h	65	04

Uwagi / Komentář / Komentáře

PL: Zasilacz w komplecie

CZ: Napájení je součástí dodávky

SK: Napájanie je súčasťou dodávky

EN: Power supply included

Materiál / Material / Material

PL: aluminium

CZ: hliník

SK: hliník

EN: aluminum

Optymalne warunki eksploatacji:

Optimální provozní podmínky:

Optimálne prevádzkové podmienky:

Optimal operating conditions:

PL: temperatura.: od -25°C do +60°C

wilgotność: <85% ciśnienie: 690-1060 hPa

CZ: teplota: od -25 ° C do + 60 ° C

vlhkost: <85% tlak: 690-1060 hPa

SK: teplota: od -25 ° C do + 60 ° C

vlhkost: <85% tlak: 690-1060 hPa

EN: temperature: from -25 ° C to + 60 ° C

humidity: <85% pressure: 690-1060 hPa

BroLux

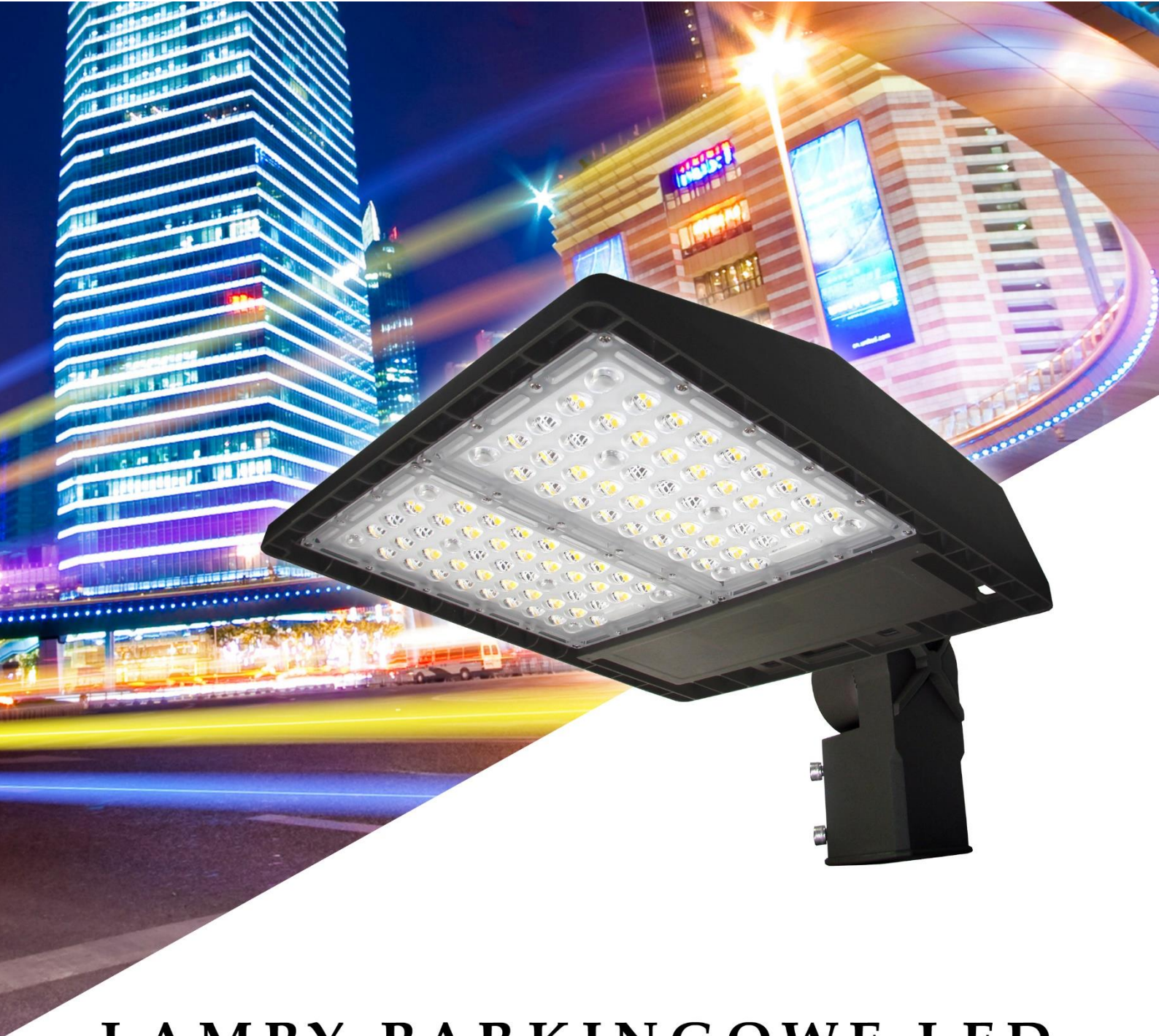

LAMPY PARKINGOWE LED

Lampy parkingowe LED używane do oświetlania dużych powierzchni takich jak parkingi, place budowy, hale, osiedla. Oprócz zalet wynikających z zastosowanej technologii LED takich jak energooszczędność i wydajność świetlna, lampy parkingowe oferują również możliwość montażu zarówno na słupie (używając uchwyty na słup z regulowanym kątem nachylenia) lub na elewacji budynku (dzięki zastosowaniu regulowanego uchwyty naświetlaczewego). Diody japońskiej marki **Nichia** i zasilacz marki **Meanwell** pozwala na długoletnią bezawaryjną pracę, a zastosowanie odgromnika dodatkowo zabezpiecza lampę na wypadek wyładowań atmosferycznych

LAMPA PARKINGOWA ULICZNA LED

CZ: LED parkovací pouliční lampa / SK: LED parkovaciepouličné lampy / EN: LED parking street lamp



Driver
MW
MEAN WELL
MODEL:
HLG

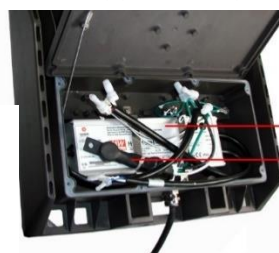

Zasilacz MeanWell HLG
Ściemniálny 0-10V



Ochrona przeciwprzepięciowa
PHILIPS 10kA
Wydłuża życie lampy

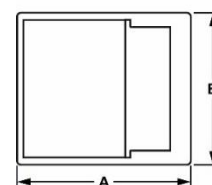
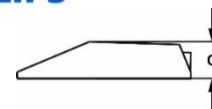

INDEX	ABC				Tc [K]		A [mm]	B [mm]	C [mm]	
012178	Bahira LED	60 W	7 200 lm	120 lm/W	4000 K	Szary Śedá Śedá Grey	385	340	80	5902216791879
012179	Bahira LED	60 W	7 200 lm	120 lm/W	5700 K		385	340	80	5902216791886
012176	Bahira LED	100 W	12 000 lm	120 lm/W	4000 K		385	340	80	5902216791893
012177	Bahira LED	100 W	12 000 lm	120 lm/W	5700 K		385	340	80	5902216791909
012121	Bahira LED	150 W	18 000 lm	120 lm/W	4000 K		385	340	80	5902216791534
012175	Bahira LED	150 W	18 000 lm	120 lm/W	6500 K		385	340	80	5902216791923
012181	Bahira LED	200 W	24 000 lm	120 lm/W	4000 K		385	340	80	5902216791930
012180	Bahira LED	200 W	24 000 lm	120 lm/W	5700 K		385	340	80	5902216791947
012183	Bahira LED	300 W	36 000 lm	120 lm/W	5700 K		385	340	105	5902216791954

AC 230V	SMD3030	70x150°	0-10V	10
CRI>80	50000h	65	IN&OUT	≥0.93

Materiał / Materiál / Material

PL: aluminium

CZ: hliník

SK: hliník

EN: aluminum

Optymalne warunki eksploatacji:

Optimální provozní podmínky:

Optimálne prevádzkové podmienky:

Optimal operating conditions:

PL: temperatura: od -25°C do +60°C

wilgotność: <85% ciśnienie: 690-1060 hPa

CZ: teplota: od -25°C do +60°C

vlhkost: <85% tlak: 690-1060 hPa

SK: teplota: od -25°C do +60°C

vlhkosc: <85% tlak: 690-1060 hPa

EN: temperature: from -25°C to +60°C

humidity: <85% pressure: 690-1060 hPa

Dostępne akcesor



012187 Uchwyt uchylny Short
Ø60mm, Kąt regulacji: 180°



012188 Uchwyt naświetlaczowy Whort
Kąt regulacji: 180°



012185 Odgromnik 15kA
Inventronics



012186 Odgromnik 10kA
Philips

Uwagi / Komentář / Komentáre

PL: Zasilacz w komplecie

CZ: Napájení je součástí dodávky

SK: Napájanie je súčasťou dodávky

EN: Power supply included

SABRA



LAMPA PARKINGOWA ULICZNA LED

CZ: LED parkovací pouliční lampa/ SK: LED parkovaciepouličné lampy/ EN: LED parking street lamp



Driver

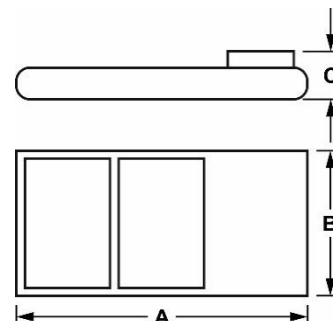

INDEX	ABC				PF	Tc[K]		A [mm]	B [mm]	C [mm]	
012581	SABRA LED	300 W	38 400 lm	128 lm/W	≥0.9	4000 K	Szary Šedá Šedá Grey	520	321	105	5902216796843

Dostępne akcesoria



012608 Uchwyt do lampy ulicznej LED

AC 230V	SMD3030	150°x65°	IP
80	50000h	66	IN&OUT

Materiał / Materiál / Material

PL: aluminium

CZ: hliník

SK: hliník

EN: aluminum

Optymalne warunki eksploatacji:

Optimální provozní podmínky:

Optimálne prevádzkové podmienky:

Optimal operating conditions:

PL: temperatura.: od -25°C do +60°C

wilgotność: <85% ciśnienie: 690-1060 hPa

CZ: teplota: od -25°C do +60°C

vlhkost: <85% tlak: 690-1060 hPa

SK: teplota: od -25°C do +60°C

vlhkost: <85% tlak: 690-1060 hPa

EN: temperature: from -25°C to +60°C

humidity: <85% pressure: 690-1060 hPa

Uwagi / Komentář / Komentáre

PL: Zasilacz w komplecie

CZ: Napájení je součástí dodávky

SK: Napájanie je súčasťou dodávky

EN: Power supply included



LAMPA ULICZNA LED

CZ: LED pouliční lampa/ SK: LED pouličné lampy/ EN: LED street lamp



B



C

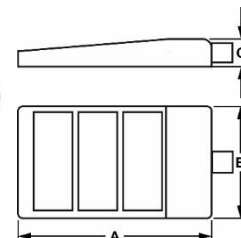

A

	INDEX	ABC				PF	Tc[K]		A [mm]	B [mm]		
A	007038	LABID LED	150 W	19 500 lm	118lm/W	≥0.97	2700 K		334	310	77	5902808807780
A	013712	LABID LED	150 W	19 500 lm	130lm/W	≥0.97	4500 K		334	310	77	5902808805205
B	013885	LABID LED	200W	23 600 lm	118lm/W	>0,95	2700 K	Szary Šedá Šedá Grey	455	310	77	5902808807490
B	013352	LABID LED	200W	26 000 lm	130lm/W	>0,95	4500 K		455	310	77	5902808801467
C	013884	LABID LED	300W	35 400 lm	118lm/W	≥0,97	2700 K		603	310	77	5902808807483
C	012592	LABID LED	300W	39 000 lm	130lm/W	≥0,97	4500 K		603	310	77	5902216796942

AC 230V	SMD3030	80°x150°	
>80	50000h	65	IN&OUT

Materiał / Materiál / Material

PL: aluminium

CZ: hliník

SK: hliník

EN: aluminum

Optymalne warunki eksploatacji:

Optimální provozní podmínky:

Optimálne prevádzkové podmienky:

Optimal operating conditions:

PL: temperatura.: od -25°C do +60°C

wilgotność: <85% ciśnienie: 690-1060 hPa

CZ: teplota: od -25°C do +60°C

vlhkost: <85% tlak: 690-1060 hPa

SK: teplota: od -25°C do +60°C

vlhkost: <85% tlak: 690-1060 hPa

EN: temperature: from -25°C to +60°C

humidity: <85% pressure: 690-1060 hPa

Dostępne akcesoria:



012594 Uchwyt do lampy Jiabin, Labid I



012595 Uchwyt do lampy Jiabin, Labid II



012596 Uchwyt do lampy Jiabin, Labid III



012597 Uchwyt do lampy Jiabin, Labid IV

Średnica wewnętrzna 66 mm

Uwagi / Komentář / Komentáre

PL: Zasilacz w komplecie

CZ: Napájení je součástí dodávky

SK: Napájanie je súčasťou dodávky

EN: Power supply included



LAMPY PARKOWE LED

LAMPA PARKOWA LED

CZ: park LED lampy/ SK: park LED žiarovky/ EN: park LED lamps



	INDEX	ABC		Lm	PF	Tc[K]		L x W x H		
A	004479	Cingen	40W	3600 lm	0,95	4500 K	135*85°	Czarny Černá Čierná Black	562*562*210mm	5902216774308
B	009686	Fareed	60W	4800 lm	0,95	4500 K	135*85°		562*562*210mm	5902216774346
C	003187	Gillam	50W	4000 lm	0,95	4500 K	120°		565*565*400mm	5902216774353
D	007952	Octavio	50W	3500 lm	0,95	4500 K	120°		605*605*425mm	5902216774360
E	001179	Conhail	40W	3837 lm	0,95	5000 K	120°		Ø480x685mm	5902216774339
F	001176	Colton	50W	4796 lm	0,95	5000 K	150°		Ø485x240 mm	5902216774322
G	004549	Bivadi	40W	3837 lm	0,95	5000 K	120°		443x443x870mm	5902216774292
H	9148	Collyer	40W	3837 lm	0,95	5000 K	150°		Ø560x400mm	5902216774315
I	012890	Willie	40W	2450 lm	0,9	4000 K	360°	Ø520x480 mm	5902216798601	
J	012887	Lacy	40W	3586 lm	0,9	4000 K	360°	Szary Šedá Šedá Grey	Ø450x320 mm	5902216798571
K	012888	Makala	30W	1922 lm	0,9	4000 K	360°		Ø450x370 mm	5902216798588
L	012889	Weslia	30W	3814 lm	0,9	4000 K	360°		Ø450x440 mm	5902216798595



AC 230V SMD NON-DIM >80



50000 h 65 IN&OUT



Materiał / Materiál / Material

PL: aluminium

CZ: hliník

SK: hliník

EN: aluminum

Uwagi / Komentář / Komentáre

PL: Zasilacz w komplecie

CZ: Napájení je součástí dodávky

SK: Napájanie je súčasťou dodávky

EN: Power supply included

BroLux

ADORA



LAMPY PARKOWE LED

CZ: park LED lampy/ SK: park LED žiarovky/ EN: park LED lamps

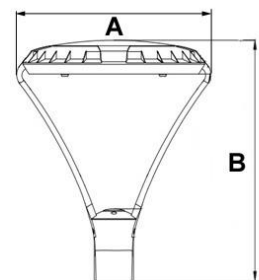

INDEX	ABC			Tc[K]		A [mm]	B [mm]	
5817	Adora LED	40W	4800 lm	4000 K	Szary	450	523	5902216786974
013865	Adora LED	60W	9000 lm	4000 K	Šedá Šedá Grey	450	523	5902808807186

Materiał / Materiál / Material

PL: aluminium

CZ: hliník

SK: hliník

EN: aluminum

Uwagi / Komentář / Komentáre

PL: Zasilacz w komplecie

CZ: Napájení je součástí dodávky

SK: Napájanie je súčasťou dodávky

EN: Power supply included



AC 230V



SMD



120x150°



NON-DIM



CRI/Ra



50000 h



IP



IN&OUT



RoHS
COMPLIANT

BroLux

OPRAWY NAJAZDOWE

OPRAWY DOGRUNTOWE

CZ: Pozemní světlo / SK: Pozemné svetlo / EN: Ground Light



A



B



C

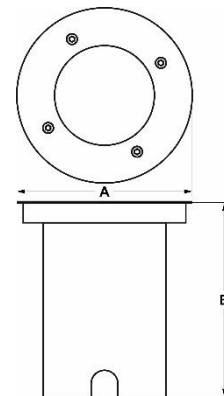

INDEX



A [mm] B [mm]



	INDEX	ABC	Power	GU10	Tc(K)	Light	Weather	A [mm]	B [mm]	Barcode
A	012868	Sibar	3*1W		4000 K	Czarny Szary		110	88	5902216798250
B	012811			GU10		Černá Šedá		108	144	5902216798069
C	012812			GU10		Čierná Šedá Black Grey		108	144	5902216798076



AC 230V



POWER LED



NON-DIM



>75



40000 h



IN&OUT



Materiał / Materiál / Material

PL: aluminium

CZ: hliník

SK: hliník

EN: aluminum

Optymalne warunki eksploatacji:

Optimální provozní podmínky:

Optimálne prevádzkové podmienky:

Optimal operating conditions:

PL: temperatura.: od -25°C do +60°C

wilgotność: <85% ciśnienie: 690-1060 hPa

CZ: teplota: od -25°C do +60°C

vlhkost: <85% tlak: 690-1060 hPa

SK: teplota: od -25°C do +60°C

vlhkost: <85% tlak: 690-1060 hPa

EN: temperature: from -25°C to +60°C

humidity: <85% pressure: 690-1060 hPa

Uwagi / Komentář / Komentáre

PL: Zasilacz w komplecie

CZ: Napájení je součástí dodávky

SK: Napájanie je súčasťou dodávky

EN: Power supply included

BroLux

www.bowi.com.pl

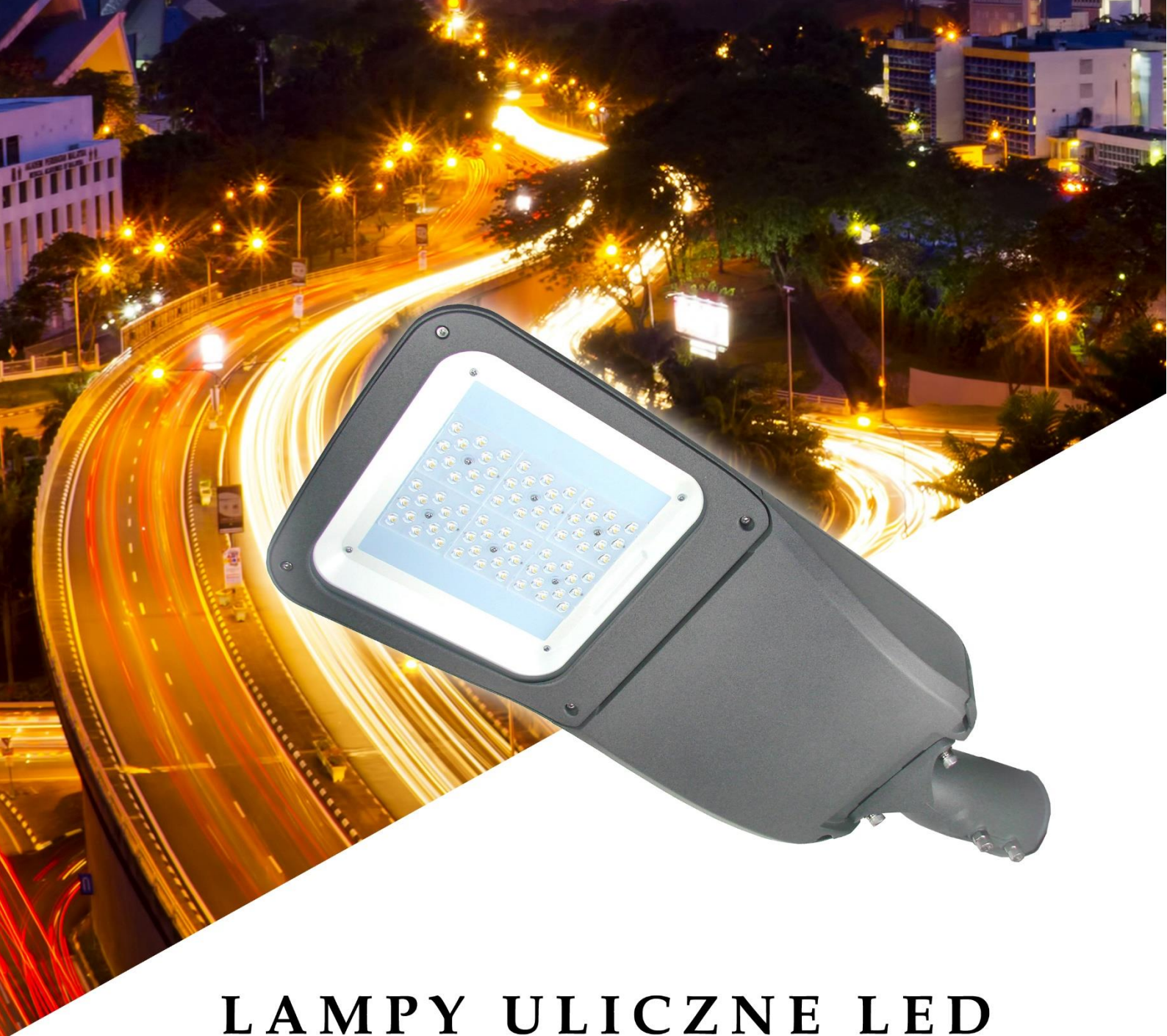

LAMPY ULICZNE LED

Oświetlenie ulic, dróg ekspresowych i miejskich, autostrad z naszymi lampami ulicznymi LED jest energooszczędne, efektywne i nowoczesne. Lampy uliczne LED cechuje długa żywotność, optymalny pobór mocy.

Aluminiowe obudowy lamp ulicznych pozwalają na bardzo dobre odprowadzanie ciepła, co wydłuża czas eksploatacji i poprawia wydajność. Beznarzędziowe otwieranie lampy oraz automatyczne odcięcie zasilania po otwarciu lampy to dodatkowe atuty ułatwiające instalację i obsługę.

RAND



LAMPA ULICZNA LED

CZ: LED pouliční lampa/ SK: LED pouličné lampy/ EN: LED street lamp



Driver LED

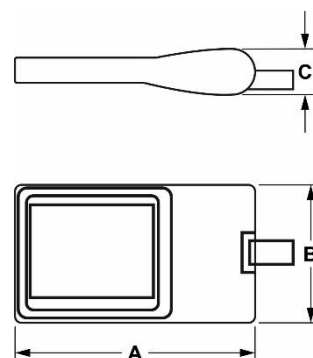

INDEX	ABC		Lm	Lm	PF	Tc[K]		A [mm]	B [mm]	C [mm]	
012908	RAND LED	30 W	3 900 lm	130 lm/W	0.95	4000 K		550	200	125	5902808802617
012593	RAND LED	50 W	6 500 lm	130 lm/W	0.95	4000 K		550	200	125	5902216796874
012681	RAND LED	60 W	7 800 lm	130 lm/W	0.95	4000 K		550	200	125	5902216797376
012682	RAND LED	100 W	13 000 lm	130 lm/W	0.95	4000 K		620	235	140	5902216797383
012683	RAND LED	150 W	19 500 lm	130 lm/W	0.95	4000 K		685	260	125	5902216797390

AC 230V	SMD3030	60x120°	
CRI(Ra)		IP	
>80	50000h	66	IN&OUT
		CE	RoHS COMPLIANT
68 mm			

Uwagi / Komentář / Komentáre

PL: Zasilacz w komplecie

CZ: Napájení je součástí dodávky

SK: Napájanie je súčasťou dodávky

EN: Power supply included

Materiał / Materiál / Material

PL: aluminium

CZ: hliník

SK: hliník

EN: aluminum

Optymalne warunki eksploatacji:

Optimální provozní podmínky:

Optimálne prevádzkové podmienky:

Optimal operating conditions:

PL: temperatura.: od -25°C do +60°C

wilgotność: <85% ciśnienie: 690-1060 hPa

CZ: teplota: od -25°C do +60°C

vlhkost: <85% tlak: 690-1060 hPa

SK: teplota: od -25°C do +60°C

vlhkost: <85% tlak: 690-1060 hPa

EN: temperature: -25°C to +60°C

humidity: <85% pressure: 690-1060 hPa

Brulux

www.bowi.com.pl

CADOG AC LED

LAMPA ULICZNA LED

CZ: LED pouliční lampa/ SK: LED pouličné lampy/ EN: LED street lamp

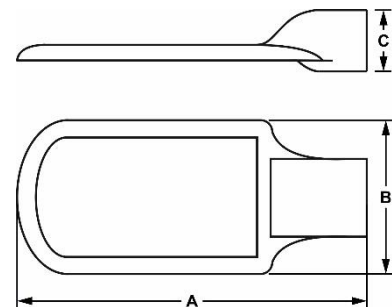

INDEX	ABC				Tc[K]		A [mm]	B [mm]	C [mm]	
011951	Cadog LED	30 W	3 000 lm	100lm/W	4000 K	Czarny Černá Čierna Black	303	130	70	5902216725393
011579	Cadog LED	50 W	5 000 lm	100lm/W	4000 K		395	168	88	5902216725416
011953	Cadog LED	70 W	7 000 lm	100lm/W	4000 K		395	168	88	5902216725409
011952	Cadog LED	100 W	10 000 lm	100lm/W	4000 K		460	220	90	5902216725394
007719	Cadog LED	150 W	15 000 lm	100lm/W	4000 K		460	220	88	5902216786875

			IP
AC 230V	SMD LED	110°	65
70	40000 h	0,95	IN&OUT

Materiał / Materiál / Material

PL: aluminium

CZ: hliník

SK: hliník

EN: aluminum

Optymalne warunki eksploatacji:

Optimální provozní podmínky:

Optimálne prevádzkové podmienky:

Optimal operating conditions:

PL: temperatura.: od -10°C do +40°C

wilgotność: <85% ciśnienie: 690-1060 hPa

CZ: teplota: od -10 ° C do + 40° C

vlhkost: <85% tlak: 690-1060 hPa

SK: teplota: od -10 ° C do + 40° C

vlhkost: <85% tlak: 690-1060 hPa

EN: temperature: from -10 ° C to + 40° C

humidity: <85% pressure: 690-1060 hPa

BroLux

LAMPA ULICZNA LED

CZ: LED pouliční lampa/ SK: LED pouličné lampy/ EN: LED street lamp



LED

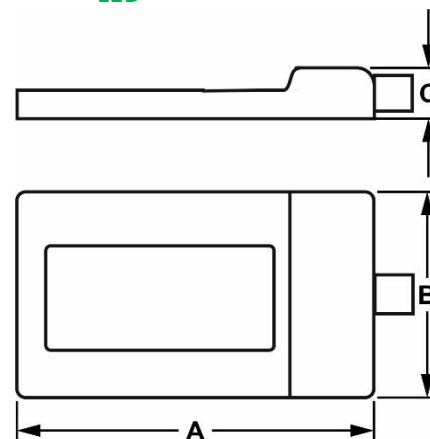

INDEX	ABC				PF	Tc[K]		A [mm]	B [mm]	C [mm]	
012557	ABLAR LED	30W	4 500 lm	150lm/W	>0,95	4000K	Szary Šedá Šedá Grey	362	170	58	5902216796430

AC 230V	SMD	70*120°	
CRI/Ra	IP	40 mm	
>70	50000h	65	CE
40 mm			RoHS COMPLIANT

Dostępne akcesoria:



012564 Uchwyt adapter lampy ulicznej 40/60mm

Materiał / Materiál / Material

PL: aluminium

CZ: hliník

SK: hliník

EN: aluminum

Optymalne warunki eksploatacji:

Optimální provozní podmínky:

Optimálne prevádzkové podmienky:

Optimal operating conditions:

PL: temperatura.: od -25°C do +60°C

wilgotność: <85% ciśnienie: 690-1060 hPa

CZ: teplota: od -25°C do +60°C

vlhkosť: <85% tlak: 690-1060 hPa

SK: teplota: od -25°C do +60°C

vlhkosť: <85% tlak: 690-1060 hPa

EN: temperature: from -25°C to +60°C

humidity: <85% pressure: 690-1060 hPa

Uwagi / Komentář / Komentáre

PL: Zasilacz w komplecie

CZ: Napájení je součástí dodávky

SK: Napájanie je súčasťou dodávky

EN: Power supply included

GREEN



LAMPA ULICZNA LED z funkcją redukcji mocy

CZ: LED pouliční lampa/ SK: LED pouličné lampy/ EN: LED street lamp



Driver

LED

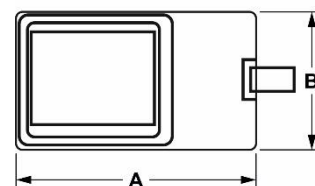
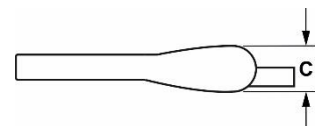

Power reduction

INDEX	ABC				PF	Tc[K]		A [mm]	B [mm]	C [mm]	
006699	GREEN LED	20 W	2 600 lm	130 lm/W	0.95	4500 K	Szary Šedá Šedá Grey	551	244	193	5902808800842
009276	GREEN LED	30 W	3 900 lm	130 lm/W	0.95	4500 K		551	244	193	5902808800859
006708	GREEN LED	40 W	5 200 lm	130 lm/W	0.95	4500 K		551	244	193	5902216712058
009277	GREEN LED	50 W	6 500 lm	130 lm/W	0.95	4500 K		551	244	193	5902808800866
006709	GREEN LED	60 W	7 800 lm	130 lm/W	0.95	4500 K		551	244	193	5902216712065
006710	GREEN LED	70 W	9 100 lm	130 lm/W	0.95	4500 K		551	244	193	5902216712072
006723	GREEN LED	80 W	10 400 lm	130 lm/W	0.95	4500 K		551	244	193	5902808800873
003561	GREEN LED	100 W	13 000 lm	130 lm/W	0.95	4500 K		551	244	193	5902216735774

AC 230V	SMD3030	60x120°	
		IP	
>80	50000h	66	IN&OUT
		CE	RoHS COMPLIANT
68 mm			

Uwagi / Komentář / Komentáre

PL: Zasilacz w komplecie

CZ: Napájení je součástí dodávky

SK: Napájanie je súčasťou dodávky

EN: Power supply included

Materiał / Materiál / Material

PL: aluminium

CZ: hliník

SK: hliník

EN: aluminum

Optymalne warunki eksploatacji:

Optimální provozní podmínky:

Optimálne prevádzkové podmienky:

Optimal operating conditions:

PL: temperatura.: od -25°C do +60°C

wilgotność: <85% ciśnienie: 690-1060 hPa

CZ: teplota: od -25°C do +60°C

vlhkost: <85% tlak: 690-1060 hPa

SK: teplota: od -25°C do +60°C

vlhkost: <85% tlak: 690-1060 hPa

EN: temperature: from -25°C to +60°C

humidity: <85% pressure: 690-1060 hPa



HOLD

LAMPA ULICZNA LED

CZ: LED pouliční lampa/ SK: LED pouličné lampy/ EN: LED street lamp

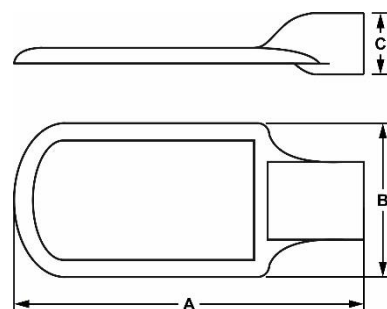

INDEX	ABC				Tc[K]		A [mm]	B [mm]	C [mm]	
045566	Hold LED	30 W	3 000 lm	100lm/W	4000 K	Czarny Černá Čierná Black	266	129	37	5902808809364
045568	Hold LED	50 W	5 000 lm	100lm/W	4000 K		306	150	37	5902808809371
045567	Hold LED	70 W	7 000 lm	100lm/W	4000 K		306	150	37	5902808809388
045569	Hold LED	100 W	10 000 lm	100lm/W	4000 K		437	200	40	5902808809395

			IP
AC 230V	SMD LED	110°	65
70	40000 h	0,95	IN&OUT

Materiał / Materiál / Material

PL: aluminium

CZ: hliník

SK: hliník

EN: aluminum

Optymalne warunki eksploatacji:

Optimální provozní podmínky:

Optimálne prevádzkové podmienky:

Optimal operating conditions:

PL: temperatura.: od -10°C do +40°C

wilgotność: <85% ciśnienie: 690-1060 hPa

CZ: teplota: od -10 ° C do + 40° C

vlhkost: <85% tlak: 690-1060 hPa

SK: teplota: od -10 ° C do + 40° C

vlhkost: <85% tlak: 690-1060 hPa

EN: temperature: from -10 ° C to + 40° C

humidity: <85% pressure: 690-1060 hPa

BroLux



NAŚWIETLACZE LED

Naświetlacze LED to wydajne produkty oświetleniowe do użytku zarówno wewnętrznego jak i zewnętrznego. Naświetlacz można zamocować w dowolnej pozycji np. na elewacji budynku. Doskonały zamiennik tradycyjnych halogenów z żarnikami sodowymi lub meta-halogenowymi. Naświetlacze LED są energooszczędne i znacznie wydajniejsze od tradycyjnych halogenów. Dzięki wysokiej klasy obudowie ze stopu aluminium naświetlacze LED zapewniają długotrwałą pracę i stabilne działanie

NAŚWIETLACZ DO OBIEKTÓW SPORTOWYCH

CZ: Světlo mety pro sportovní vyžití/ SK: Svetlomety pre športové vyžitie/ EN: Illuminator for sports facilities

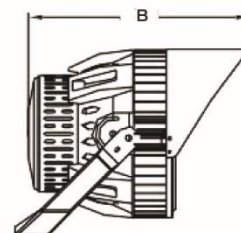

Driver



MODEL
HLG



INDEX	ABC		Lm	Lm	Tc[K]		A [mm]	B [mm]	
012516	Carly LED	480 W	62 400lm	130 lm/W	5500 K	Czarny Černá Čierna Black	363	480	59022167960103



AC 230V



SMD LED



45°



1-10V



>70



40000 h



66



Materiał / Materiál / Material

PL: aluminium

CZ: hliník

SK: hliník

EN: aluminum

Optymalne warunki eksploatacji:

Optimální provozní podmínky:

Optimálne prevádzkové podmienky:

Optimal operating conditions:

PL: temperatura.: od -25°C do +60°C

wilgotność: <85% ciśnienie: 690-1060 hPa

CZ: teplota: od -25°C do +60°C

vlhkost: <85% tlak: 690-1060 hPa

SK: teplota: od -25°C do +60°C

vlhkost: <85% tlak: 690-1060 hPa

EN: temperature: from -25°C to +60°C

humidity: <85% pressure: 690-1060 hPa

Uwagi / Komentář / Komentáre

PL: Zasilacz w komplecie

CZ: Napájení je součástí dodávky

SK: Napájanie je súčasťou dodávky

EN: Power supply included

NAŚWIETLACZ ELEWACYJNY

CZ: LED fasádání světlo / SK: LED fasádny svetlo / EN: LED facade floodlight



Driver
MEAN WELL
MODEL:
HLG

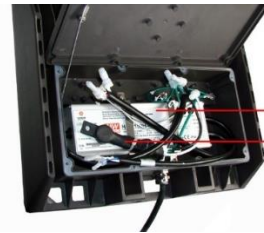

Zasilacz MeanWell HLG
Ściemniaczny 0-10V



Ochrona przeciwprzepięciowa
PHILIPS 10kA
Wydłuża życie lampy

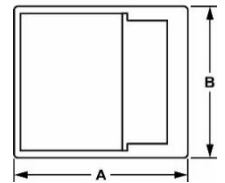
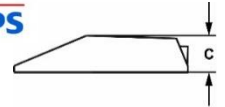

INDEX	ABC				PF	Tc[K]		A [mm]	B [mm]	C [mm]	
012178	Bahira LED	60 W	7 200 lm	120 lm/W	≥0.93	4000 K	Szary Śedá Śedá Grey	385	340	80	5902216791879
012179	Bahira LED	60 W	7 200 lm	120 lm/W	≥0.93	5700 K		385	340	80	5902216791886
012176	Bahira LED	100 W	12 000 lm	120 lm/W	≥0.93	4000 K		385	340	80	5902216791893
012177	Bahira LED	100 W	12 000 lm	120 lm/W	≥0.93	5700 K		385	340	80	5902216791909
012121	Bahira LED	150 W	18 000 lm	120 lm/W	≥0.93	4000 K		385	340	80	5902216791534
012175	Bahira LED	150 W	18 000 lm	120 lm/W	≥0.93	6500 K		385	340	80	5902216791923
012181	Bahira LED	200 W	24 000 lm	120 lm/W	≥0.93	4000 K		385	340	80	5902216791930
012180	Bahira LED	200 W	24 000 lm	120 lm/W	≥0.93	5700 K		385	340	80	5902216791947
012183	Bahira LED	300 W	36 000 lm	120 lm/W	≥0.93	5700 K		385	340	105	5902216791954

				IK
AC 230V	SMD3030	70x150°	0-10V	10
				PF
CRI>80	50000h	65	IN&OUT	≥0.93

Dostępne Akcesoria:



012187 Uchwyt uchylony Short
Ø60mm, Kąt regulacji: 180°



012188 Uchwyt naświetlaczowy Whort
Kąt regulacji: 180°



012185 Odgromnik 15kA
Inventronics



012186 Odgromnik 10kA
Philips

Materiał / Materiál / Material

PL: aluminium

CZ: hliník

SK: hliník

EN: aluminum

Optymalne warunki eksploatacji:

Optimální provozní podmínky:

Optimálne prevádzkové podmienky:

Optimal operating conditions:

PL: temperatura.: od -25°C do +60°C

wilgotność: <85% ciśnienie: 690-1060 hPa

CZ: teplota: od -25°C do +60°C

vlhkost: <85% tlak: 690-1060 hPa

SK: teplota: od -25°C do +60°C

vlhkost: <85% tlak: 690-1060 hPa

EN: temperature: from -25°C to +60°C

humidity: <85% pressure: 690-1060 hPa

Uwagi / Komentář / Komentáře

PL: Zasilacz w komplecie

CZ: Napájení je součástí dodávky

SK: Napájanie je súčasťou dodávky

EN: Power supply included

NAŚWIETLACZ LED

CZ: vecl světlomet / SK: vedie svetlomet / EN: LED floodlight

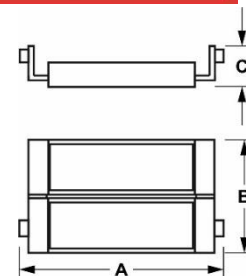

	INDEX	ABC	⚡	💡 Lm	💡 Lm/W	☂️	PF	Tc[K]	📏	A [mm]	B [mm]	C [mm]	📊
A	012940	MADOR LED	50W	6 500 lm	130lm/W	70°×140°	≥0,95	4000 K	Szary Šedá Šedá Grey	350	75	75	5902216798946
A	012941	MADOR LED	50W	6 500 lm	130lm/W	70°×140°	≥0,95	5500 K		350	75	75	5902216798953
A	013334	MADOR LED	50W	6 500 lm	130lm/W	90°	≥0,95	4000 K		350	75	75	5902808800996
B	012598	MADOR LED	100W	13 000 lm	130lm/W	70°×140°	≥0,95	4000 K		350	155	75	5902216796966
B	012937	MADOR LED	100W	13 000 lm	130lm/W	70°×140°	≥0,95	5500 K		350	155	75	5902216798960
B	013920	MADOR LED	100W	13 000 lm	130lm/W	70°×140°	≥0,95	6000 K		350	155	75	5902216700567
C	006958	MADOR LED	200W	23 600 lm	118lm/W	70°×140°	≥0,95	2700 K		350	315	75	5902808807728
C	012938	MADOR LED	200W	26 000 lm	130lm/W	70°×140°	≥0,95	4000 K		350	315	75	5902216798977
C	012939	MADOR LED	200W	26 000 lm	130lm/W	70°×140°	≥0,95	5500 K		350	315	75	5902216798984
C	013332	MADOR LED	200W	26 000 lm	130lm/W	90°	≥0,95	4000 K		350	315	75	5902808801009
C	013333	MADOR LED	200W	26 000 lm	130lm/W	90°	≥0,95	5500 K		350	315	75	5902808801016

🔌	🏠	🔌	⚠️
AC 230V	SMD3030	IN&OUT	
CRi(Ra)	🕒	IP	🌊
≥80	50000h	65	
CE	RoHS COMPLIANT		

Uwagi / Komentář / Komentáre
 PL: Zasilacz w komplecie
 CZ: Napájení je součástí dodávky
 SK: Napájanie je súčasťou dodávky
 EN: Power supply included

Materiał / Materiál / Material

PL: aluminium
 CZ: hliník
 SK: hliník
 EN: aluminum

Optymalne warunki eksploatacji:
 Optimální provozní podmínky:
 Optimálne prevádzkové podmienky:
 Optimal operating conditions:

PL: temperatura.: od -25°C do +60°C
 wilgotność: <85% ciśnienie: 690-1060 hPa
 CZ: teplota: od -25°C do +60°C
 vlhkost: <85% tlak: 690-1060 hPa
 SK: teplota: od -25°C do +60°C
 vlhkost: <85% tlak: 690-1060 hPa
 EN: temperature: from -25°C do +60°C
 humidity: <85% pressure: 690-1060 hPa



NAŚWIETLACZ LED

CZ: veďl svĕtlomet / SK: vedie svetlomet / EN: LED floodlight

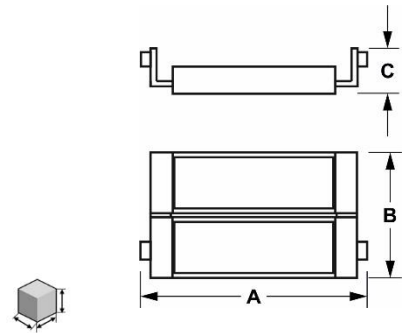

INDEX	ABC					PF	Tc[K]		A [mm]	B [mm]	C [mm]	
013879	MADOR LED	200W	23 600 lm	118m/W	70°×140°	≥0,95	2700 K		350	315	75	5902808807438

AC 230V	SMD3030	IN&OUT	
≥80	50000h	65	

Uwagi / Komentář / Komentáre

PL: Zasilacz w komplecie

CZ: Napájení je součástí dodávky

SK: Napájanie je súčasťou dodávky

EN: Power supply included

Materiał / Materiál / Material

PL: aluminium

CZ: hliník

SK: hliník

EN: aluminum

Optymalne warunki eksploatacji:

Optimální provozní podmínky:

Optimálne prevádzkové podmienky:

Optimal operating conditions:

PL: temperatura.: od -25°C do +60°C

wilgotność: <85% ciśnienie: 690-1060 hPa

CZ: teplota: od -25°C do +60°C

vlhkost: <85% tlak: 690-1060 hPa

SK: teplota: od -25°C do +60°C

vlhkost: <85% tlak: 690-1060 hPa

EN: temperature: from -25°C do +60°C

humidity: <85% pressure: 690-1060 hPa

NAŚWIETLACZ LED

CZ: vedl světlomet / SK: vedie svetlomet / EN: LED floodlight

Driver

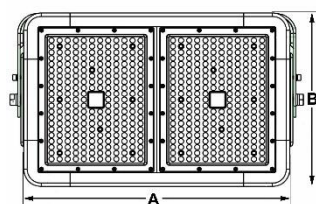
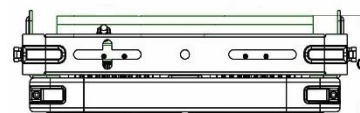

INDEX	ABC				Tc[K]		A [mm]	B [mm]	C [mm]	
012609	Paxton LED	200 W	34126 lm	142 lm/W	4500 K	Czarny Niebieski / Černá Modrá / Čierná Modrá / Black Blue	300	250	120	5902216797000
012610	Paxton LED	250 W	35000 lm	140 lm/W	4500 K		460	300	150	5902216797017
012611	Paxton LED	480 W	67350 lm	140 lm/W	4500 K		670	300	150	5902216797024
012612	Paxton LED	720 W	108000 lm	150 lm/W	4500 K		560	460	150	5902216797031
012613	Paxton LED	1000 W	127999 lm	128 lm/W	4000 K		670	560	200	5902216797048
012614	Paxton LED	1250 W	175000 lm	140 lm/W	4500 K		880	560	200	5902216797055

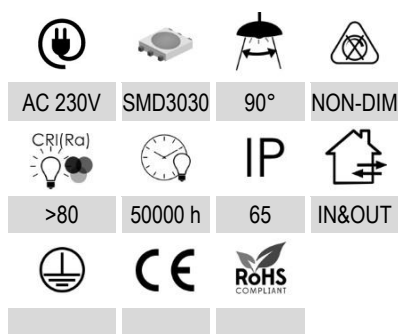

Dostępne Akcesoria:



013382 Soczewka 45°
do Paxton



013383 Soczewka 60°
do Paxton

Materiał / Materiál / Material

PL: aluminium

CZ: hliník

SK: hliník

EN: aluminum

Uwagi / Komentář / Komentáre

PL: Zasilacz w komplecie

CZ: Napájení je součástí dodávky

SK: Napájanie je súčasťou dodávky

EN: Power supply included

Optymalne warunki eksploatacji:

Optimální provozní podmínky:

Optimálne prevádzkové podmienky:

Optimal operating conditions:

PL: temperatura.: od -25°C do +60°C

wilgotność: <85% ciśnienie: 690-1060 hPa

CZ: teplota: od -25°C do +60°C

vlhkost: <85% tlak: 690-1060 hPa

SK: teplota: od -25°C do +60°C

vlhkost: <85% tlak: 690-1060 hPa

EN: temperature: from -25°C to +60°C

humidity: <85% pressure: 690-1060 hPa

WALL WASHER LED

CZ: LED dioda na stěnové podložce / SK: LED dióda na stenách / EN: LED wallwasher



PHILIPS

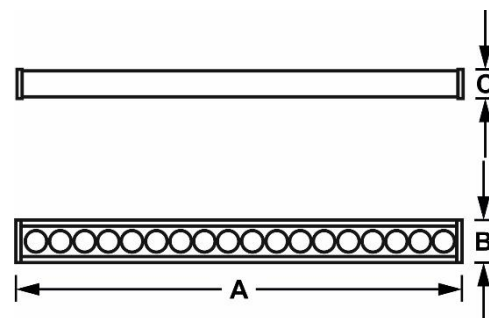

INDEX	ABC				Tc[K]		A [mm]	B [mm]	C [mm]	
012857	Garan LED	24W	1800 lm	75 lm/W	4000 K	Szary Šedá Šedá Grey	600	46,5	70	5902216798328
012882	Garan LED	36W	2700 lm	75 lm/W	3000 K		1000	45	59	5902216798373
012856	Garan LED	36W	2700 lm	75 lm/W	4000 K		1000	45	59	5902216797987

AC 230V	SMD	30°	NON-DIM
CR1(Ra)	40000 h	IP 65	IN&OUT
PF 0,9	RoHS COMPLIANT	CE	RoHS COMPLIANT

Materiał / Materiál / Material

PL: aluminium

CZ: hliník

SK: hliník

EN: aluminum

Optymalne warunki eksploatacji:

Optimální provozní podmínky:

Optimálne prevádzkové podmienky:

Optimal operating conditions:

PL: temperatura.: od -25°C do +60°C

wilgotność: <85% ciśnienie: 690-1060 hPa

CZ: teplota: od -25°C do +60°C

vlhkost: <85% tlak: 690-1060 hPa

SK: teplota: od -25°C do +60°C

vlhkost: <85% tlak: 690-1060 hPa

EN: temperature: from -25°C to +60°C

humidity: <85% pressure: 690-1060 hPa

Uwagi / Komentář / Komentáre

PL: Zasilacz w komplecie

CZ: Napájení je součástí dodávky

SK: Napájanie je súčasťou dodávky

EN: Power supply included

NAŚWIETLACZ LED

CZ: vedl světlomet / SK: vedie svetlomet / EN: LED floodlight



INDEX	ABC				Tc[K]		A [mm]	B [mm]	C [mm]	
045565	Dorin LED	50 W	5000 lm	100 lm/W	4500 K	Czarny Černá Čierna Black	180	150	25	5902808809340
045564	Dorin LED	50 W	5000 lm	100 lm/W	6500 K		180	150	25	5902808809357
006135	Dorin LED	100 W	10500 lm	105 lm/W	4500 K		270	220	25	5902216788572
006136	Dorin LED	100 W	10500 lm	105 lm/W	6500 K		270	220	25	5902216788589

AC 230V	SMD3030	110°	NON-DIM
>70	50000 h	65	IN&OUT

Materiał / Materiál / Material

PL: aluminium

CZ: hliník

SK: hliník

EN: aluminum

Uwagi / Komentář / Komentáre

PL: Zasilacz w komplecie

CZ: Napájení je součástí dodávky

SK: Napájanie je súčasťou dodávky

EN: Power supply included

Optymalne warunki eksploatacji:

Optimální provozní podmínky:

Optimálne prevádzkové podmienky:

Optimal operating conditions:

PL: temperatura.: od -25°C do +60°C

wilgotność: <85% ciśnienie: 690-1060 hPa

CZ: teplota: od -25°C do +60°C

vlhkost: <85% tlak: 690-1060 hPa

SK: teplota: od -25°C do +60°C

vlhkost: <85% tlak: 690-1060 hPa

EN: temperature: from -25°C to +60°C

humidity: <85% pressure: 690-1060 hPa

BOLD



NAŚWIETLACZ LED

CZ: veďl svĕtlomet / SK: vedie svetlomet / EN: LED floodlight



INDEX	ABC							A [mm]	B [mm]	C [mm]	
045517	Bold	50 W	6500 lm	128lm/W	70°x140°	4000 K	Czarny Černá Čierny Black	180	150	27	5902808809098
045521	Bold	50 W	6500 lm	128lm/W	90°	4000 K		180	150	27	5902808810056
045522	Bold	50 W	6500 lm	128lm/W	70°x140°	5500 K		180	150	27	5902808809104
045518	Bold	100 W	12800 lm	128lm/W	70°x140°	4000 K		270	200	27	5902808809111
045523	Bold	100 W	12800 lm	128lm/W	70°x140°	5500 K		270	200	27	5902808809128
045519	Bold	150 W	19500 lm	128lm/W	70°x140°	4000 K		330	225	32,5	5902808809135
045524	Bold	150 W	19500 lm	128lm/W	70°x140°	5500 K		330	225	32,5	5902808809142
045526	Bold	200 W	26000 lm	128lm/W	70°x140°	2700 K		385	270	32,5	5902808809159
045520	Bold	200 W	26000 lm	128lm/W	70°x140°	4000 K		385	270	32,5	5902808809166
045525	Bold	200 W	26000 lm	128lm/W	70°x140°	5500 K		385	270	32,5	5902808809173

AC 230V	SMD LED		>80
40000 h	IP 65		

Materiał / Materiál / Material

PL: aluminium

CZ: hliník

SK: hliník

EN: aluminum

Optymalne warunki eksploatacji:

Optimální provozní podmínky:

Optimálne prevádzkové podmienky:

Optimal operating conditions:

PL: temperatura.: od -10°C do +25°C

wilgotność: <85% ciśnienie: 690-1060 hPa

CZ: teplota: od -10 °C do + 25 °C

vlhkost: <85% tlak: 690-1060 hPa

SK: teplota: od -10 °C do + 25 °C

vlhkost: <85% tlak: 690-1060 hPa

EN: temperature: from -10 °C to + 25 °C

humidity: <85% pressure: 690-1060 hPa



ARCHITEKTONICZNE LAMPY LED

CZ: LED svítidlo/ SK: LED svietidlo/ EN: LED lamp

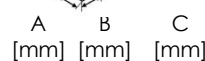

	INDEX						A [mm]	B [mm]	C [mm]	
A	013062	Flow LED	1x3 W	270 lm	4000 K	Zieleń mchu RAL 6005 Mechově zelená RAL 6005 Machovo zelená RAL 6005 Moss green RAL 6005	114	28	76	5902216799738
B	013063	Flow LED	1x3 W	270 lm	4000 K	Czarny Černá Čierny Black	114	28	76	5902216799745
C	013636	Flow LED	1x3 W	270 lm	4000 K	Antracytowy RAL 7016 antracitová RAL 7016 antracitová RAL 7016 anthracite RAL 7016	114	28	76	5902808804512
D	013064	Flow LED	1x6 W	540 lm	4000 K	Zieleń mchu RAL 6005 Mechově zelená RAL 6005 Machovo zelená RAL 6005 Moss green RAL 6005	172	29	76	5902216799752
E	013065	Flow LED	1x6 W	540 lm	4000 K	Czarny Černá Čierny Black	172	29	76	5902216799769
F	013637	Flow LED	1x6 W	540 lm	4000 K	Antracytowy RAL 7016 antracitová RAL 7016 antracitová RAL 7016 anthracite RAL 7016	172	29	76	5902808804529
G	013066	Flow LED	1x9 W	810 lm	4000 K	Zieleń mchu RAL 6005 Mechově zelená RAL 6005 Machovo zelená RAL 6005 Moss green RAL 6005	250	30	83	5902216799776
H	013639	Flow LED	1x9 W	810 lm	4000 K	Czarny Černá Čierny Black	250	30	83	5902808804536
I	013638	Flow LED	1x9 W	810 lm	4000 K	Antracytowy RAL 7016 antracitová RAL 7016 antracitová RAL 7016 anthracite RAL 7016	250	30	83	5902808804543



AC 230V



SMD LED



60



NON-DIM



>80



40000 h

Materiał / Materiál / Material

PL: aluminium

CZ: hliník

SK: hliník

EN: aluminium

Uwagi / Komentář / Komentáre

PL: Zasilacz w komplecie

CZ: Napájení je součástí dodávky

SK: Napájanie je súčasťou dodávky

EN: Power supply included

IP



IN&OUT



54

ARCHITEKTONICZNE LAMPY LED

CZ: LED svítidlo / SK: LED sietidlo / EN: LED lamp



	INDEX	ABC		Lm	Tc[K]		A [mm]	B [mm]	C [mm]	
A	012878	Flow LED	2x3 W	540 lm	4000K	Zieleń mchu RAL 6005 Mechově zelená RAL 6005 Machovo zelená RAL 6005 Moss green RAL 6005	114	28	90	5902216789746
B	013069	Flow LED	2x3 W	540 lm	4000 K	Czarny Černá Čierny Black	114	28	90	5902216799783
C	013640	Flow LED	2x3 W	540 lm	4000 K	Antracytowy RAL 7016 antracitová RAL 7016 antracitová RAL 7016 anthracite RAL 7016	114	28	90	5902808804550
D	012879	Flow LED	2x6 W	1080 lm	4000 K	Zieleń mchu RAL 6005 Mechově zelená RAL 6005 Machovo zelená RAL 6005 Moss green RAL 6005	172	28	90	5902216719132
E	013068	Flow LED	2x6 W	1080 lm	4000 K	Czarny Černá Čierny Black	172	28	90	5902216799806
F	013067	Flow LED	2x9 W	1620 lm	4000 K	Zieleń mchu RAL 6005 Mechově zelená RAL 6005 Machovo zelená RAL 6005 Moss green RAL 6005	250	28	90	5902216799790

AC 230V	SMD LED	60	NON-DIM
CRI(Ra) >80	IP 40000 h	54	IN&OUT
CE	RoHS COMPLIANT		

Materiał / Materiál / Material

PL: aluminium
CZ: hliník
SK: hliník
EN: aluminium

Uwagi / Komentář / Komentáre

PL: Zasilacz w komplecie
CZ: Napájení je součástí dodávky
SK: Napájanie je súčasťou dodávky
EN: Power supply included

FREON



OPRAWY ARCHITEKTONICZNE BEZ ŹRÓDŁA ŚWIATŁA

CZ: Svítlidla bez zdroje světla / SK: Svetidlá bez zdroja svetla / EN: Luminaires without a light source

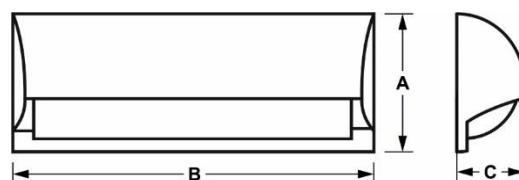

INDEX	ABC		A [mm]	B [mm]	C [mm]	
012869	Freon	Szary Šedá Šedá Grey	125	250	114	5902216798243



AC 230V



E27

IP

54



IN&OUT



Materiał / Materiál / Material

PL: aluminium

CZ: hliník

SK: hliník

EN: aluminium

Br**o**lux

www.bowi.com.pl

ARCHITEKTONICZNE LAMPY LED

CZ: LED svítidlo/ SK: LED svetidlo/ EN: LED lamp



INDEX



A [mm]

B [mm]

C [mm]



	INDEX	ABC	Power	Lm	Tc[K]	Beam angle	A [mm]	B [mm]	C [mm]	Barcode
A	013073	Kreon LED	2x3 W	196 lm	4000 K	Zieleń mchu RAL 6005 Mechově zelená RAL 6005 Machovo zelená RAL 6005 Moss green RAL 6005	100	100	100	5902216799813
B	013072	Kreon LED	2x3 W	196 lm	4000 K	Czarny Černá Čierny Black	100	100	100	5902216799820
C	013634	Kreon LED	2x3 W	196 lm	4000 K	Biały biała Bielá white	100	100	100	5902808804475
D	013635	Kreon LED	2x3 W	196 lm	4000 K	Antracytowy RAL 7016 antracitová RAL 7016 antracitová RAL 7016 anthracite RAL 7016	100	100	100	5902808804482
E	013070	Kreon LED	2x3 W	196 lm	4000 K	Zieleń mchu RAL 6005 Mechově zelená RAL 6005 Machovo zelená RAL 6005 Moss green RAL 6005	130	108	98	5902216799837
F	013071	Kreon LED	2x3 W	196 lm	4000 K	Czarny Černá Čierny Black	130	108	98	5902216799844



AC 230V



SMD LED



0-120°



NON-DIM



CRI(Ra)



IP



IN&OUT

>80

40000 h

54

IN&OUT



Materiał / Materiál / Material

PL: aluminium

CZ: hliník

SK: hliník

EN: aluminium

Uwagi / Komentář / Komentáre

PL: Zasilacz w komplecie

CZ: Napájení je součástí dodávky

SK: Napájanie je súčasťou dodávky

EN: Power supply included

SURMUR



ARCHITEKTONICZNE LAMPY LED

CZ: LED svítidlo/ SK: LED svietidlo/ EN: LED lamp



A



B



C



D



	INDEX	ABC			Tc[K]		A [mm]	B [mm]	C [mm]	
A	013075	Surmur LED	1x6 W	390 lm	4000 K	Zieleń mchu RAL 6005 Mechově zelená RAL 6005 Machovo zelená RAL 6005 Moss green RAL 6005	107	78	78	5902216799851
B	013074	Surmur LED	1x6 W	390 lm	4000 K	Czarny Černá Čierny Black	107	78	78	5902216799868
C	013076	Surmur LED	2x6 W	710 lm	4000 K	Zieleń mchu RAL 6005 Mechově zelená RAL 6005 Machovo zelená RAL 6005 Moss green RAL 6005	185	67	105	5902216799875
D	013077	Surmur LED	2x6 W	710 lm	4000 K	Czarny Černá Čierny Black	185	67	105	5902216799882



AC 230V



SMD LED



NON-DIM



CRI(Ra)



40000 h



IP



IN&OUT



RoHS COMPLIANT

Materiał / Materiál / Material

PL: aluminium

CZ: hliník

SK: hliník

EN: aluminium

Uwagi / Komentář / Komentáre

PL: Zasilacz w komplecie

CZ: Napájení je součástí dodávky

SK: Napájanie je súčasťou dodávky

EN: Power supply included

BroLux

www.bowi.com.pl

BRIK

OPRAWY ARCHITEKTONICZNE

CZ: fasádní lampy LED / SK: fasádne LED svietidlá / EN: elevational LED lamps



INDEX	ABC			Tc[K]		A [mm]	B [mm]	C [mm]	
004478	Brik LED	30 W	2100 lm	4500 K	Czarny Černá Čierná Black	145	170	225	5902216771062

AC 230V	COB	95°	NON-DIM
>75	40000 h	65	IN&OUT

Materiał / Materiál / Material

PL: aluminium

CZ: hliník

SK: hliník

EN: aluminium

Uwagi / Komentář / Komentáre

PL: Zasilacz w komplecie

CZ: Napájení je součástí dodávky

SK: Napájanie je súčasťou dodávky

EN: Power supply included

Brolux

www.bowi.com.pl

OPRAWY ARCHITEKTONICZNE

CZ: fasádní lampy LED / SK: fasádne LED svietidlá / EN: elevational LED lamps



INDEX	ABC			Tc[K]		A [mm]	B [mm]	C [mm]	
004492	Bitel LED	18 W	1620 lm	4500 K	Czarny Černá Čierná Black	150	150	175	5902216771055

AC 230V	COB	40°	NON-DIM
>75	40000 h	65	IN&OUT

Materiał / Materiál / Material

PL: aluminium

CZ: hliník

SK: hliník

EN: aluminium

Uwagi / Komentář / Komentáre

PL: Zasilacz w komplecie

CZ: Napájení je součástí dodávky

SK: Napájanie je súčasťou dodávky

EN: Power supply included

ARCHITEKTONICZNE LAMPY LED

CZ: LED svítidlo/ SK: LED svietidlo/ EN: LED lamp



INDEX	ABC			Tc[K]		A [mm]	B [mm]	C [mm]	
045653	FERRA LED	13 W	25lm/W	4000 K	Antracytowy RAL 7016 antracitová RAL 7016 antracitová RAL 7016 anthracite RAL 7016	98	250	90	5902808809883
045652	FERRA LED	13 W	25lm/W	4000 K	Czarny Černá Čierny Black	98	250	90	5902808809890

AC 230V	SMD LED	58	NON-DIM
>80	40000 h	65	IN&OUT

Materiał / Materiál / Material

PL: aluminium

CZ: hliník

SK: hliník

EN: aluminium

Uwagi / Komentář / Komentáre

PL: Zasilacz w komplecie

CZ: Napájení je součástí dodávky

SK: Napájanie je súčasťou dodávky

EN: Power supply included

ARCHITEKTONICZNE LAMPY LED

CZ: LED svítidlo/ SK: LED svietidlo/ EN: LED lamp



INDEX	ABC			Tc[K]		A [mm]	B [mm]	C [mm]	
045675	Lambo LED	7 W	25lm/W	4000 K	Czarny Černá Čierny Black	220	120	90	5902808809906

AC 230V	SMD LED	NON-DIM	IN&OUT
CRI/Ra	40000 h	IP 65	
>80			

Materiał / Material / Material

PL: aluminium

CZ: hliník

SK: hliník

EN: aluminium

Uwagi / Komentář / Komentáre

PL: Zasilacz w komplecie

CZ: Napájení je součástí dodávky

SK: Napájanie je súčasťou dodávky

EN: Power supply included

ARCHITEKTONICZNE LAMPY LED

CZ: LED svítidlo/ SK: LED svietidlo/ EN: LED lamp



INDEX	ABC			Tc[K]		A [mm]	B [mm]	C [mm]	
045674	Rissa LED	7 W	25lm/W	4000 K	Czarny Černá Čierny Black	230	75	110	5902808809913

AC 230V	SMD LED	NON-DIM	IN&OUT
CRI/Ra	40000 h	IP	
>80	40000 h	65	
CE	RoHS COMPLIANT		

Materiał / Material / Material

PL: aluminium

CZ: hliník

SK: hliník

EN: aluminium

Uwagi / Komentář / Komentáre

PL: Zasilacz w komplecie

CZ: Napájení je součástí dodávky

SK: Napájanie je súčasťou dodávky

EN: Power supply included

ARCHITEKTONICZNE LAMPY LED

CZ: LED svítidlo/ SK: LED svietidlo/ EN: LED lamp



INDEX						A [mm]	B [mm]	C [mm]	
045673	Riva LED	13 W	25lm/W	4000 K	Czarny Černá Čierny Black	250	100	40	5902808809920

AC 230V	SMD LED	NON-DIM	IN&OUT
>80	40000 h	65	

Materiał / Material / Material

PL: aluminium

CZ: hliník

SK: hliník

EN: aluminium

Uwagi / Komentář / Komentáre

PL: Zasilacz w komplecie

CZ: Napájení je součástí dodávky

SK: Napájanie je súčasťou dodávky

EN: Power supply included



PLAFONY LED

Plafony LED to doskonałe rozwiązanie do oświetlenia klatek schodowych, pomieszczeń biurowych, budynków, korytarzy, ciągów komunikacyjnych.





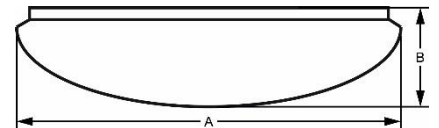

Dzięki użyciu wytrzymałych materiałów plafony zachowują długi termin eksploatacji przy optymalnych parametrach oświetleniowych. Stopień ochrony IP65 pozwala na użytkowanie plafonów zarówno wewnątrz jak i na zewnątrz pomieszczeń. Dzięki zastosowaniu czujnika mikrofalowego plafon jest bezobsługowy, zapala się dopiero gdy poziom jasności spadnie poniżej określonego poziomu. Może być zamocowany na dowolnej płaskiej powierzchni.

SPERE IP44 MICROWAVE SENSOR

PLAFONY LED Z CZUJNIKIEM RUCHU

CZ: Svítidlo přisazené LED s pohybovým čidlem / SK: Svítidlo přisazené LED s pohybovým čidlem / EN: LED Ceiling light with microwave sensor



INDEX	ABC					PF			A [mm]	B [mm]	
001908	SPERE LED	16 W	1200 lm	75 lm/W	4500 K	>0.5	Microwave	Biały biłá Bielá white	280	108	5902216748903



AC 230V

SMD LED

110°



IP



>80

40000 h

44



Uwagi / Komentář / Komentáre

PL: Zasilacz w komplecie

CZ: Napájení je součástí dodávky

SK: Napájanie je súčasťou dodávky

EN: Power supply included

Uwagi / Komentář / Komentáre

PL: Załączenie przy świetle <30lux

CZ: Působí na okolní světlo pod 30lux

SK: Pôsobí na okolité svetlo pod 30lux

EN: Turn on under light level of 30lux

Uwagi / Komentář / Komentáre

PL: Wyłączenie po 20s bez ruchu

CZ: doba svícení 20s

SK: Doba svietenia 20s

EN: Turn off after 20s without motion

Materiał / Material / Material

PL: Tworzywo sztuczne PC

CZ: PC Plast

SK: PC Plast

EN: PC Plastic

Optymalne warunki eksploatacji:

Optimální provozní podmínky:

Optimal operating conditions:

PL: temperatura.: od -25°C do +60°C

wilgotność: <85% ciśnienie: 690-1060 hPa

CZ: teplota: od -25°C do +60°C

vlhkosť: <85% tlak: 690-1060 hPa

SK: teplota: od -25°C do +60°C

vlhkosť: <85% tlak: 690-1060 hPa

EN: temperature: from -25°C to +60°C

humidity: <85% pressure: 690-1060 hPa

Uwagi / Komentář / Komentáre

PL: Zasięg wykrywania ruchu max 6m (<24°C)

CZ: Maximální dosah čidla 6m (<24°C)

SK: Maximálny dosah čidla 6m (<24°C)

EN: Max. motion detection distance 6m (<24°C)

Uwagi / Komentář / Komentáre

PL: Kąt działania czujnika 360°

CZ: Rozsah čidla pohyblu 360°

SK: Uhol činnosti pohybového čidla 360°

EN: Sensor angle 360°



SUNS IP65



PLAFONY LED

CZ: Svítidlo přisazené LED / SK: Svítidlo přisazené LED / EN: LED Ceiling light

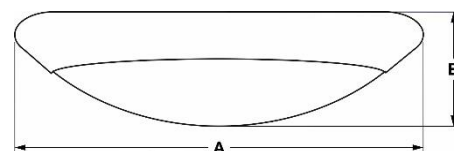

INDEX	ABC	AC 230V	SMD LED	110°	Tc[K]	PF	Micro wave	D/N SENSOR	IP	Color	A [mm]	B [mm]	Barcode
7169	SUNS LED	16 W	1200 lm	75 lm/W	4000 K	>0.5	-	-	65	Biały bílá Bielá white	300	80	5902216748910
009653	SUNS LED	16 W	1200 lm	75 lm/W	4000 K	>0.5	Micro wave	-	65		300	80	5902216724907
007741	SUNS LED	16 W	1200 lm	75 lm/W	4500 K	>0.5	-	D/N SENSOR	65		300	80	5902216748927



AC 230V

SMD LED

110°



80

40000 h



Uwagi / Komentář / Komentáre

PL: Zasilacz w komplecie

CZ: Napájení je součástí dodávky

SK: Napájanie je súčasťou dodávky

EN: Power supply included

Uwagi / Komentář / Komentáre

PL: Załączenie przy świetle <30lux

CZ: Působí na okolní světlo pod 30lux

SK: Pôsobí na okolité svetlo pod 30lux

EN: Turn on under light level of 30lux

Uwagi / Komentář / Komentáre

PL: Wyłączenie po 20s bez ruchu

CZ: doba svícení 20s

SK: Doba svietenia 20s

EN: Turn off after 20s without motion

Materiał / Materiál / Material

PL: Tworzywo sztuczne PC

CZ: PC Plast

SK: PC Plast

EN: PC Plastic

Optymalne warunki eksploatacji:

Optimální provozní podmínky:

Optimálne prevádzkové podmienky:

Optimal operating conditions:

PL: temperatura.: od -25°C do +60°C

wilgotność: <85% ciśnienie: 690-1060 hPa

CZ: teplota: od -25°C do +60°C

vlhkost: <85% tlak: 690-1060 hPa

SK: teplota: od -25°C do +60°C

vlhkost: <85% tlak: 690-1060 hPa

EN: temperature: from -25°C to +60°C

humidity: <85% pressure: 690-1060 hPa

Uwagi / Komentář / Komentáre

PL: Zasięg wykrywania ruchu max 6m (<24°C)

CZ: Maximální dosah čidla 6m (<24°C)

SK: Maximálny dosah čidla 6m (<24°C)

EN: Max. motion detection distance 6m (<24°C)

Uwagi / Komentář / Komentáre

PL: Kąt działania czujnika 360°

CZ: Rozsah čidla pohyblu 360°

SK: Uhol činnosti pohybového čidla 360°

EN: Sensor angle 360°



PLAFONY LED

CZ: Svítidlo přisazené LED Samsung LED / SK: Svítidlo přisazené LED Samsung LED / EN: LED Ceiling light with Samsung LED

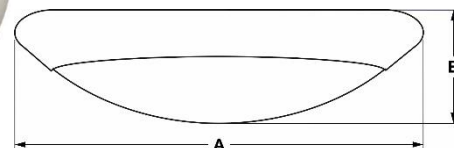

INDEX	ABC	AC 230V	Lm	Lm	Tc[K]	PF	Micro wave	IP	Color	A [mm]	B [mm]	Barcode	
8027	SUNS LED	16 W	1200 lm	75 lm/W	4500 K	>0.5	Micro wave	-	65	Biały biła Bielá white	300	80	5902216748958



AC 230V

SMD LED

110°



80

60000 h



Uwagi / Komentář / Komentáre

PL: Zasilacz w komplecie

CZ: Napájení je součástí dodávky

SK: Napájanie je súčasťou dodávky

EN: Power supply included

Uwagi / Komentář / Komentáre

PL: Załączenie przy świetle <30lux

CZ: Působí na okolní světlo pod 30lux

SK: Pôsobí na okolité svetlo pod 30lux

EN: Turn on under light level of 30lux

Uwagi / Komentář / Komentáre

PL: Wyłączenie po 20s bez ruchu

CZ: doba svícení 20s

SK: Doba svietenia 20s

EN: Turn off after 20s without motion

Materiał / Materiál / Material

PL: Tworzywo sztuczne PC

CZ: PC Plast

SK: PC Plast

EN: PC Plastic

Optymalne warunki eksploatacji:

Optimální provozní podmínky:

Optimálne prevádzkové podmienky:

Optimal operating conditions:

PL: temperatura.: od -25°C do +60°C

wilgotność: <85% ciśnienie: 690-1060 hPa

CZ: teplota: od -25°C do +60°C

vlhkost: <85% tlak: 690-1060 hPa

SK: teplota: od -25°C do +60°C

vlhkost: <85% tlak: 690-1060 hPa

EN: temperature: from -25°C to +60°C

humidity: <85% pressure: 690-1060 hPa

Uwagi / Komentář / Komentáre

PL: Zasięg wykrywania ruchu max 6m (<24°C)

CZ: Maximální dosah čidla 6m (<24°C)

SK: Maximálny dosah čidla 6m (<24°C)

EN: Max. motion detection distance 6m (<24°C)

Uwagi / Komentář / Komentáre

PL: Kąt działania czujnika 360°

CZ: Rozsah čidla pohyblu 360°

SK: Uholi činnosti pohybového čidla 360°







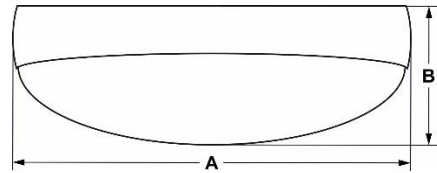

EN: Sensor angle 360°











MARI IP65 MICROWAVE SENSOR

PLAFONY LED Z CZUJNIKIEM RUCHU

CZ: Svítidlo přisazené LED s pohybovým čidlem / SK: Svítidlo přisazené LED s pohybovým čidlem / EN: LED Ceiling light with microwave sensor



INDEX						PF			A [mm]	B [mm]	
007742	MARI LED	24 W	1800 lm	75 lm/W	4500 K	0,5	Microwave	Biały biłá Bielá white	340	123	5902216748873
006657	MARI LED	30 W	2250 lm	75 lm/W	4500 K	0,9	Microwave		340	123	5902216748880

			
AC 230V	SMD LED	110°	
			
>80	40000 h	65	
			

Uwagi / Komentář / Komentáre

PL: Zasilacz w komplecie

CZ: Napájení je součástí dodávky

SK: Napájanie je súčasťou dodávky

EN: Power supply included

Uwagi / Komentář / Komentáre

PL: Załączenie przy świetle <30lux

CZ: Působí na okolní světlo pod 30lux

SK: Pôsobí na okolité svetlo pod 30lux

EN: Turn on under light level of 30lux

Uwagi / Komentář / Komentáre

PL: Wyłączenie po 20s bez ruchu

CZ: doba svícení 20s

SK: Doba svietenia 20s

EN: Turn off after 20s without motion

Materiał / Material / Materiál

PL: Tworzywo sztuczne PC

CZ: PC Plast

SK: PC Plast

EN: PC Plastic

Optymalne warunki eksploatacji:

Optimální provozní podmínky:

Optimálne prevádzkové podmienky:

Optimal operating conditions:

PL: temperatura.: od -25°C do +60°C

wilgotność: <85% ciśnienie: 690-1060 hPa

CZ: teplota: od -25°C do +60°C

vlhkost: <85% tlak: 690-1060 hPa

SK: teplota: od -25°C do +60°C

vlhkost: <85% tlak: 690-1060 hPa

EN: temperature: from -25°C to +60°C

humidity: <85% pressure: 690-1060 hPa

Uwagi / Komentář / Komentáre

PL: Zasięg wykrywania ruchu max 6m (<24°C)

CZ: Maximální dosah čidla 6m (<24°C)

SK: Maximálny dosah čidla 6m (<24°C)

EN: Max. motion detection distance 6m (<24°C)

Uwagi / Komentář / Komentáre

PL: Kąt działania czujnika 360°

CZ: Rozsah čidla pohyblu 360°

SK: Uhol činnosti pohybového čidla 360°

EN: Sensor angle 360°







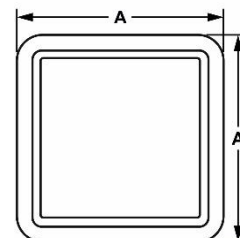
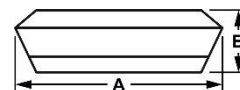

RIGBY IP65 MICROWAVE SENSOR

PLAFONY LED Z CZUJNIKIEM RUCHU

CZ: Svítidlo přisazené LED s pohybovým čidlem / SK: Svítidlo přisazené LED s pohybovým čidlem / EN: LED Ceiling light with microwave sensor



INDEX	ABC					PF			A [mm]	B [mm]	
008331	RIGBY LED	16 W	1200 lm	75lm/W	4500 K	>0.5	Microwave	Biały biła Bielá white	300	90	5902216748897



AC 230V

SMD LED

110°



85

40000 h

65



Uwagi / Komentář / Komentáre

PL: Zasilacz w komplecie

CZ: Napájení je součástí dodávky

SK: Napájanie je súčasťou dodávky

EN: Power supply included

Uwagi / Komentář / Komentáre

PL: Załączenie przy świetle <30lux

CZ: Působí na okolní světlo pod 30lux

SK: Pôsobí na okolité svetlo pod 30lux

EN: Turn on under light level of 30lux

Uwagi / Komentář / Komentáre

PL: Wyłączenie po 20s bez ruchu

CZ: doba svícení 20s

SK: Doba svietenia 20s

EN: Turn off after 20s without motion

Materiał / Materiál / Material

PL: Tworzywo sztuczne PC

CZ: PC Plast

SK: PC Plast

EN: PC Plastic

Optymalne warunki eksploatacji:

Optimální provozní podmínky:

Optimálne prevádzkové podmienky:

Optimal operating conditions:

PL: temperatura.: od -25°C do +60°C

wilgotność: <85% ciśnienie: 690-1060 hPa

CZ: teplota: od -25°C do +60°C

vlhkost: <85% tlak: 690-1060 hPa

SK: teplota: od -25°C do +60°C

vlhkost: <85% tlak: 690-1060 hPa

EN: temperature: from -25°C to +60°C

humidity: <85% pressure: 690-1060 hPa

Uwagi / Komentář / Komentáre

PL: Zasięg wykrywania ruchu max 6m (<24°C)

CZ: Maximální dosah čidla 6m (<24°C)

SK: Maximálny dosah čidla 6m (<24°C)

EN: Max. motion detection distance 6m (<24°C)

Uwagi / Komentář / Komentáre

PL: Kąt działania czujnika 360°

CZ: Rozsah čidla pohyblu 360°

SK: Uhol činnosti pohybového čidla 360°

EN: Sensor angle 360°



JARIN



PLAFONY LED

CZ: Svítidlo přisazené LED / SK: Svítidlo přisazené LED / EN: LED Ceiling light

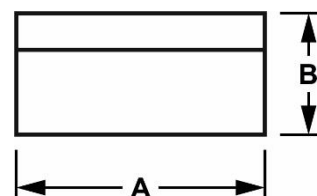

INDEX	ABC			Tc[K]		A [mm]	B [mm]	
012231	Jarin	12 W	1080 lm	4000 K	Biały biła biely white	280	65	5902216793712
012232	Jarin	24 W	2160 lm	4000 K		280	65	5902216793729
011573	Jarin	30 W	2700 lm	4000 K		330	65	5902808805304
011572	Jarin	36 W	3240 lm	4000 K		330	67	5902808805328
011571	Jarin	48 W	4320 lm	4000 K		400	65	5902808805335

			IP
AC 230V	SMD LED	120°	65
>80	40000 h		
PF	CE	RoHS COMPLIANT	
0,5			

Materiał / Materiál / Material

PL: Tworzywo sztuczne

CZ: Plást,

SK: Plást

EN: Plastic

Uwagi / Komentář / Komentáre

PL: Zasilacz w komplecie

CZ: Napájení je součástí dodávky

SK: Napájanie je súčasťou dodávky

EN: Power supply included



www.bowi.com.pl

PLAFONY LED

CZ: Svítidlo přisazené LED / SK: Svítidlo přisazené LED / EN: LED Ceiling light

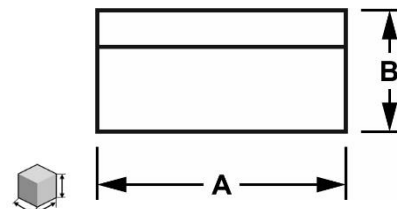

INDEX	ABC				Tc[K]		A [mm]	B [mm]	
7160	JARIN	12 W	1080 lm	90 lm/W	4000 K	Biały biła biely white	280	65	5902216793699
012230	JARIN	24 W	2160 lm	90 lm/W	4000 K		280	70	5902216793705
011574	JARIN	30 W	2700 lm	90 lm/W	4000 K		330	65	5902808805311
013994	JARIN	48 W	4230 lm	90 lm/W	4000 K		400	65	5902808809012

AC 230V	SMD LED	120°	65
>80	40000 h	0,5	RoHS COMPLIANT

Uwagi / Komentář / Komentáre

PL: Zasilacz w komplecie

CZ: Napájení je součástí dodávky

SK: Napájanie je súčasťou dodávky

EN: Power supply included

Uwagi / Komentář / Komentáre

PL: Załączenie przy świetle <30lux

CZ: Působí na okolní světlo pod 30lux

SK: Pôsobí na okolité svetlo pod 30lux

EN: Turn on under light level of 30lux

Uwagi / Komentář / Komentáre

PL: Wyłączenie po 20s bez ruchu

CZ: doba svícení 20s

SK: Doba svietenia 20s

EN: Turn off after 20s without motion

Materiał / Materiál / Material

PL: Tworzywo sztuczne PC

CZ: PC Plast

SK: PC Plast

EN: PC Plastic

Optymalne warunki eksploatacji:

Optimální provozní podmínky:

Optimálne prevádzkové podmienky:

Optimal operating conditions:

PL: temperatura.: od -10°C do +25°C

wilgotność: <85% ciśnienie: 690-1060 hPa

CZ: teplota: od -10 ° C do + 25 ° C

vlhkost: <85% tlak: 690-1060 hPa

SK: teplota: od -10 ° C do + 25 ° C

vlhkost: <85% tlak: 690-1060 hPa

EN: temperature: from -10 ° C to + 25 ° C

humidity: <85% pressure: 690-1060 hPa

Uwagi / Komentář / Komentáre

PL: Zasięg wykrywania ruchu max 6m (<24°C)

CZ: Maximální dosah čidla 6m (<24°C)

SK: Maximálny dosah čidla 6m (<24°C)

EN: Max. motion detection distance 6m (<24°C)

Uwagi / Komentář / Komentáre

PL: Kąt działania czujnika 360°

CZ: Rozsah čidla pohybu 360°

SK: Uhol činnosti pohybového čidla 360°

EN: Sensor angle 360°

JAREN



PLAFONY LED

CZ: Svítidlo přisazené LED / SK: Svítidlo přisazené LED / EN: LED Ceiling light

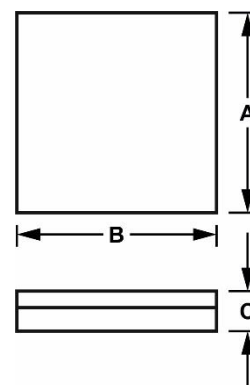

INDEX	ABC		Lm	Lm	Tc[K]		A [mm]	B [mm]	C [mm]	
012547	Jaren LED	12 W	975 lm	90 lm/W	4000 K	Biały biła Bielá white	280	280	65	5902216796393
012952	Jaren LED	24 W	2160 lm	90lm/W	4000 K		280	280	65	5902216799127
013727	Jaren LED	30 W	2700 lm	90lm/W	4000 K		330	330	65	5902808805281
013728	Jaren LED	36 W	3240 lm	90lm/W	4000 K		330	330	65	5902808805298

AC 230V	SMD LED	120°	>80
40000 h	IP 65	PF 0,5	RoHS COMPLIANT

Materiał / Materiál / Material

PL: Tworzywo sztuczne PC

CZ: PC Plast

SK: PC Plast

EN: PC Plastic

Uwagi / Komentář / Komentáre

PL: Zasilacz w komplecie

CZ: Napájení je součástí dodávky

SK: Napájanie je súčasťou dodávky

EN: Power supply included



JAREN



PLAFONY LED

CZ: Svítidlo přisazené LED / SK: Svítidlo přisazené LED / EN: LED Ceiling light

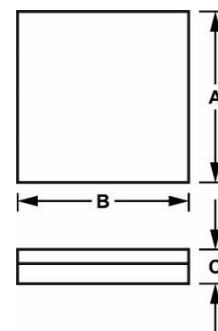

INDEX	ABC				Tc[K]		A [mm]	B [mm]	C [mm]	
012546	Jaren LED	12 W	1080 lm	90 lm/W	4000 K	Biały	280	280	65	5902216796409
012953	Jaren LED	24 W	2160 lm	90 lm/W	4000 K	Biała Bielá white	280	280	65	5902216799134

AC 230V	SMD LED	120°	>80
40000 h	IP	PF	Microwave
RoHS COMPLIANT	RoHS COMPLIANT	RoHS COMPLIANT	RoHS COMPLIANT

Materiał / Material / Material

PL: Tworzywo sztuczne PC

CZ: PC Plast

SK: PC Plast

EN: PC Plastic

Uwagi / Komentář / Komentáre

PL: Zasilacz w komplecie

CZ: Napájení je součástí dodávky

SK: Napájanie je súčasťou dodávky

EN: Power supply included

Uwagi / Komentář / Komentáre

PL: Zasięg wykrywania ruchu max 6m (<24°C)

CZ: Maximální dosah čidla 6m (<24°C)

SK: Maximálny dosah čidla 6m (<24°C)

EN: Max. motion detection distance 6m (<24°C)

Uwagi / Komentář / Komentáre

PL: Kąt działania czujnika 360°

CZ: Rozsah čidla pohyblu 360°

SK: Uhol činnosti pohybového čidla 360°

EN: Sensor angle 360°

Uwagi / Komentář / Komentáre

PL: Zażęczenie przy świetle <30lux

CZ: Působí na okolní světlo pod 30lux

SK: Působí na okolité svetlo pod 30lux

EN: Turn on under light level of 30lux

Uwagi / Komentář / Komentáre

PL: Wyłączenie po 20s bez ruchu

CZ: doba svícení 20s

SK: Doba svietenia 20s

EN: Turn off after 20s without motion



PLAFONY LED

CZ: Svítidlo přisazené LED / SK: Svítidlo přisazené LED / EN: LED Ceiling light

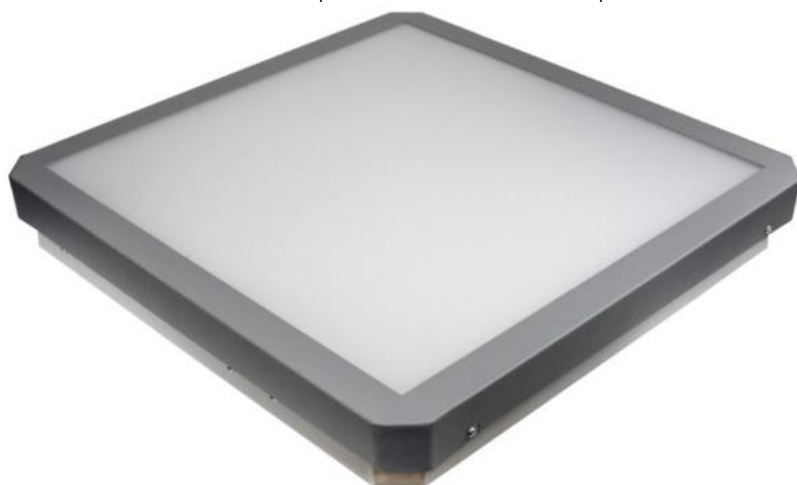

INDEX	ABC				Tc[K]			A [mm]	B [mm]	
013168	RAVA LED	38 W	4370 lm	115lm/W	4000 K	Microwave		410	67	5902808800392

AC 230V	SMD LED	120	>80
40000 h	IP	PF	
20	0,9		
CE	RoHS COMPLIANT		

Uwagi / Komentář / Komentáře

PL: Zażyczenie przy świetle <30lux

CZ: Působí na okolní světlo pod 30lux

SK: Pôsobí na okolité svetlo pod 30lux

EN: Turn on under light level of 30lux

Uwagi / Komentář / Komentáře

PL: Wyłączenie po 20s bez ruchu

CZ: doba svícení 20s

SK: Doba svietenia 20s

EN: Turn off after 20s without motion

Materiał / Materiál / Material

PL: Stal

CZ: Ocel

SK: Oceľ

EN: Steel

Uwagi / Komentář / Komentáře

PL: Zasilacz w komplecie

CZ: Napájení je součástí dodávky

SK: Napájanie je súčasťou dodávky

EN: Power supply included

Uwagi / Komentář / Komentáře

PL: Zasięg wykrywania ruchu max 6m (<24°C)

CZ: Maximální dosah čidla 6m (<24°C)

SK: Maximálny dosah čidla 6m (<24°C)

EN: Max. motion detection distance 6m (<24°C)

Uwagi / Komentář / Komentáře

PL: Kąt działania czujnika 360°

CZ: Rozsah čidla pohyblu 360°

SK: Uholi činnosti pohybového čidla 360°

EN: Sensor angle 360°

RAVA



PLAFONY LED

CZ: Svítidlo přisazené LED / SK: Svítidlo přisazené LED / EN: LED Ceiling light

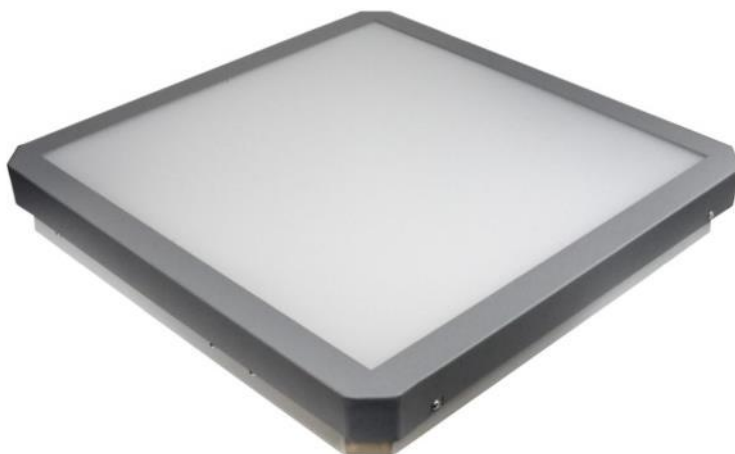

INDEX	ABC				Tc[K]		A [mm]	B [mm]	
013172	RAVA LED	38 W	4370 lm	115m/W	4000 K	Szary Šedá Šedá Grey	410	67	5902808800392



AC 230V



SMD LED



120



>80



IP

PF



40000 h

20

0,9



CE



Materiał / Materiál / Material

PL: Stal

CZ: Ocel

SK: Oceľ

EN: Steel

Uwagi / Komentář / Komentáre

PL: Zasilacz w komplecie

CZ: Napájení je součástí dodávky

SK: Napájanie je súčasťou dodávky

EN: Power supply included

Brolux

www.bowi.com.pl

VINGON

PLAFONY LED

CZ: Svítidlo přisazené LED / SK: Svítidlo přisazené LED / EN: LED Ceiling light

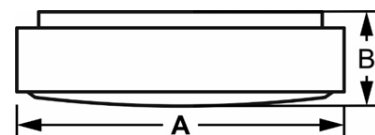

INDEX	ABC →				PF		IP		A [mm]	B [mm]	
011660	VINGON LED	12 W	900 lm	4500 K	0,5	-	20	Biały biela white + Srebrny Stieborná stříbrná silver	257	80	5902216711075
001850	VINGON LED	18 W	1170 lm	4500 K	0,5	-	20		300	106	5902216722040
013036	VINGON LED	24 W	2040 lm	4000 K	0,5	-	20		350	116	5902216799578
011654	VINGON LED	9 W	675 lm	4500 K	0,5	Microwave	20		257	80	5902216766044
011652	VINGON LED	12 W	900 lm	4500 K	0,5	Microwave	20		257	80	5902216719880
011655	VINGON LED	15 W	1125 lm	4500 K	0,5	Microwave	20		343	98	5902216711082
007718	VINGON LED	18 W	1170 lm	4500 K	0,5	Microwave	20		330	106	5902216724440
003206	VINGON LED	24 W	2040 lm	4000 K	0,5	Microwave	20		350	116	5902216722033
007775	VINGON LED	12 W	900 lm	4500 K	0,5	-	44		257	80	5902216766709
007776	VINGON LED	18 W	1170 lm	4500 K	0,5	-	44		300	106	5902216766693
007777	VINGON LED	12 W	900 lm	4500 K	0,5	Microwave	44	257	80	5902216766686	
007780	VINGON LED	15 W	1125 lm	4500 K	0,5	Microwave	44	343	98	5902216788473	



AC 230V

SMD LED

120°



>80

40000 h



Uwagi / Komentář / Komentáře

PL: Zażądanie przy świetle <30lux

CZ: Působí na okolní světlo pod 30lux

SK: Pôsobí na okolité svetlo pod 30lux

EN: Turn on under light level of 30lux

Uwagi / Komentář / Komentáře

PL: Wyłączenie po 20s bez ruchu

CZ: doba svícení 20s

SK: Doba svietenia 20s

EN: Turn off after 20s without motion

Materiał / Materiál / Material

PL: Tworzywo sztuczne, blacha stalowa

CZ: Plast, kovový výlisek

SK: Plast, kovový výlisek

EN: Plastic, steel plate

Uwagi / Komentář / Komentáře

PL: Zasilacz w komplecie

CZ: Napájení je součástí dodávky

SK: Napájanie je súčasťou dodávky

EN: Power supply included

Uwagi / Komentář / Komentáře

PL: Zasięg wykrywania ruchu max 6m (<24°C)

CZ: Maximální dosah čidla 6m (<24°C)

SK: Maximálny dosah čidla 6m (<24°C)

EN: Max. motion detection distance 6m (<24°C)

Uwagi / Komentář / Komentáře

PL: Kąt działania czujnika 360°

CZ: Rozsah čidla pohyblu 360°

SK: Uhol činnosti pohybového čidla 360°





EN: Sensor angle 360°

VITAL

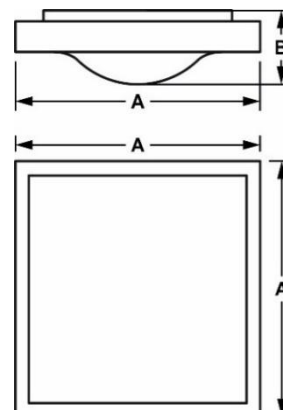
PLAFONY LED

CZ: Svítidlo přisazené LED / SK: Svítidlo přisazené LED / EN: LED Ceiling light



INDEX	ABC		 Lm	 Tc [K]	PF		A [mm]	B [mm]	
011659	Vital LED	12 W	1020 lm	4500 K	0,5	Biały biła bielá white + Srebrny Stieborná stříbrná silver	270	80	5902216719897
013027	Vital LED	24 W	2040 lm	4000 K	0,5		380	70	5902216799585
007155	Vital LED	18 W	1170 lm	4500 K	0,5	Antracytowy RAL 7016 antracitová RAL 7016 antracitová RAL 7016 anthracite RAL 7016	300	83	5902216729032



AC 230V

SMD LED

180°



80

40000 h



Materiał / Materiál / Material

PL: Tworzywo sztuczne, blacha stalowa

CZ: Plast, kovový výlisek

SK: Plast, kovový výlisek

EN: Plastic, steel plate

Uwagi / Komentář / Komentáře

PL: Zasilacz w komplecie

CZ: Napájení je součástí dodávky

SK: Napájanie je súčasťou dodávky

EN: Power supply included

PLAFONY LED

CZ: Svítidlo přisazené LED / SK: Svítidlo přisazené LED / EN: LED Ceiling light

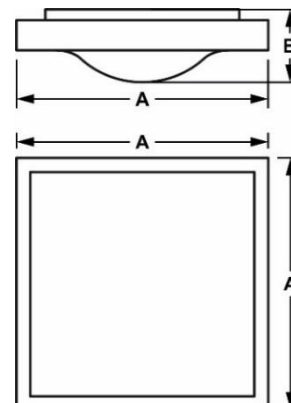

INDEX	ABC			Tc[K]		PF		A [mm]	B [mm]	
011657	Vitali LED	12 W	1020 lm	4000 K	Microwave	0,5	Biały biła	270	79	5902216723733
010132	Vitali LED	18 W	1170 lm	4000 K	Microwave	0,5	white +	300	83	5902216729056
006415	Vitali LED	24 W	2040 lm	4000 K	Microwave	0,5	Srebrny Stieborná stříbrná silver	372	84	5902216729063
011656	Vitali LED	24 W	2040 lm	4000 K	Microwave	0,5	Antracytowy RAL 7016 antracitová RAL 7016 antracitová RAL 7016 anthracite RAL 7016	375	75	5902216766679

AC 230V	SMD LED	180°	IP 44
80	40000 h	RoHS COMPLIANT	CE

Uwagi / Komentář / Komentáre

PL: Zażyczenie przy świetle <30lux

CZ: Působí na okolní světlo pod 30lux

SK: Působí na okolité svetlo pod 30lux

EN: Turn on under light level of 30lux

Uwagi / Komentář / Komentáre

PL: Wyłączenie po 20s bez ruchu

CZ: doba svícení 20s

SK: Doba svietenia 20s

EN: Turn off after 20s without motion

Materiał / Materiál / Materiál

PL: Tworzywo sztuczne, blacha stalowa

CZ: Plast, kovový výlisek

SK: Plast, kovový výlisek

EN: Plastic, steel plate

Uwagi / Komentář / Komentáre

PL: Zasilacz w komplecie

CZ: Napájení je součástí dodávky

SK: Napájanie je súčasťou dodávky

EN: Power supply included

Uwagi / Komentář / Komentáre

PL: Zasięg wykrywania ruchu max 6m (<24°C)

CZ: Maximální dosah čidla 6m (<24°C)

SK: Maximálny dosah čidla 6m (<24°C)

EN: Max. motion detection distance 6m (<24°C)

Uwagi / Komentář / Komentáre

PL: Kąt działania czujnika 360°

CZ: Rozsah čidla pohyblu 360°

SK: Uhol činnosti pohybového čidla 360°

EN: Sensor angle 360°

PLAFONY LED

CZ: Svítidlo přisazené LED / SK: Svítidlo přisazené LED / EN: LED Ceiling light

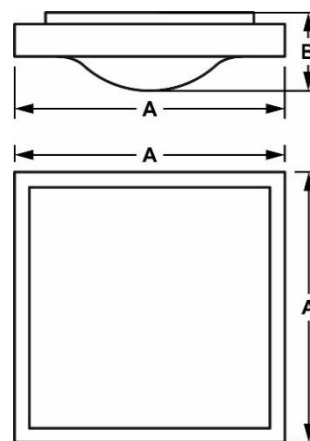

INDEX	ABC			Tc[K]	PF		A [mm]	B [mm]	
013037	Wilton LED	24 W	2040 lm	4000 K	0,5	Czarny Černá Čierna Black	372	80	5902216799592

AC 230V	SMD LED	180°	
80	40000 h	20	

Materiał / Materiál / Material

PL: Tworzywo sztuczne, blacha stalowa

CZ: Plast, kovový výlisek

SK: Plast, kovový výlisek

EN: Plastic, steel plate

Uwagi / Komentář / Komentáre

PL: Zasilacz w komplecie

CZ: Napájení je součástí dodávky

SK: Napájanie je súčasťou dodávky

EN: Power supply included

KADER

PLAFONY E27

CZ: Svítidlo přisazené bez zdroje světla / SK: Svítidlo přisazené bez zdroja svetla / EN: Ceiling light without light source

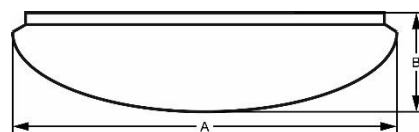

A [mm] B [mm]



INDEX	ABC	Power	Socket	Features	Color	Material	A [mm]	B [mm]	Barcode
012662	Kader	25 W	E27		Biały biła Bielá white	PC+PMMA	270	103	5902216797574
012580	Kader	25 W	E27	Microwave			270	103	5902216797567
012663	Kader	60 W	E27		Biały biła Bielá white	PC+Szkło PC+Sklo PC+Sklo PC+Glass	275	117	5902216797550
012661	Kader	60 W	E27	Microwave			275	117	5902216797543



AC 230V



180°



Uwagi / Komentář / Komentáre

PL: Załączenie przy świetle <30lux

CZ: Působí na okolní světlo pod 30lux

SK: Pôsobí na okolité svetlo pod 30lux

EN: Turn on under light level of 30lux

Uwagi / Komentář / Komentáre

PL: Wyłączenie po 20s bez ruchu

CZ: doba svícení 20s

SK: Doba svietenia 20s

EN: Turn off after 20s without motion

Optymalne warunki eksploatacji:

Optimální provozní podmínky:

Optimálne prevádzkové podmienky:

Optimal operating conditions:

PL: temperatura.: od -25°C do +60°C

wilgotność: <85% ciśnienie: 690-1060 hPa

CZ: teplota: od -25°C do +60°C

vlhkost: <85% tlak: 690-1060 hPa

SK: teplota: od -25°C do +60°C

vlhkost: <85% tlak: 690-1060 hPa

EN: temperature: from -25°C do +60°C

humidity: <85% pressure: 690-1060 hPa

Uwagi / Komentář / Komentáre

PL: Zasięg wykrywania ruchu max 6m (<24°C)

CZ: Maximální dosah čidla 6m (<24°C)

SK: Maximálny dosah čidla 6m (<24°C)

EN: Max. motion detection distance 6m (<24°C)

Uwagi / Komentář / Komentáre

PL: Kąt działania czujnika 360°

CZ: Rozsah čidla pohyblu 360°

SK: Uholi činnosti pohybového čidla 360°

EN: Sensor angle 360°

Brolux

NEGO



PLAFONY LED

CZ: Svítidlo přisazené LED / SK: Svítidlo přisazené LED / EN: LED Ceiling light

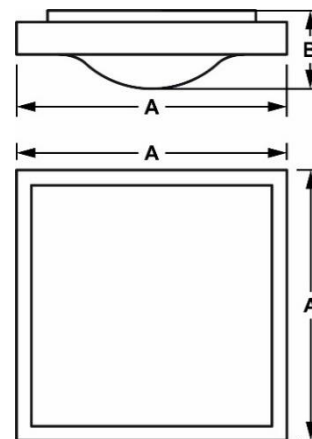

INDEX	ABC			Tc[K]	PF		A [mm]	B [mm]	
009427	NEGO LED	32 W	2579 lm	4000 K	0,9	Czarny Černá Čierna Black	435	60	5902216789265

AC 230V	SMD LED	180°	
CRI(Ra)	40000 h	20	

Materiał / Materiál / Material

PL: Tworzywo sztuczne, blacha stalowa

CZ: Plast, kovový výlisek

SK: Plast, kovový výlisek

EN: Plastic, steel plate

Uwagi / Komentář / Komentáre

PL: Zasilacz w komplecie

CZ: Napájení je součástí dodávky

SK: Napájanie je súčasťou dodávky

EN: Power supply included

www.bowi.com.pl

BroLux

TUDUR



PLAFONY LED

CZ: Svítidlo přisazené LED / SK: Svítidlo přisazené LED / EN: LED Ceiling light



INDEX	ABC				Tc[K]		A [mm]	B [mm]	
011569	Tudur LED	10 W	900 lm	90 lm/W	4000 K	Biały bielá	250	50	5902808807841
011568	Tudur LED	15 W	1350 lm	90 lm/W	4000 K	Bielá white	250	50	5902808807858

AC 230V	SMD LED	120°	>80
40000 h	IP	PF	PIR

Materiał / Materiál / Material

PL: Tworzywo sztuczne PC

CZ: PC Plast

SK: PC Plast

EN: PC Plastic

Uwagi / Komentář / Komentáre

PL: Zasilacz w komplecie

CZ: Napájení je součástí dodávky

SK: Napájanie je súčasťou dodávky

EN: Power supply included

www.bowi.com.pl

BroLux



DOWNLIGHTY LED

Downlighty LED to unikalna alternatywa dla oświetlenia w biurach, sklepach, salach konferencyjnych, mieszkaniach, a dzięki wysokiemu stopniowi ochrony IP54 downlighty sprawdzą się także w miejscach narażonych na wilgoć jak np. łazienki, sauny, baseny.

Downlighty LED są stosowane wszędzie tam gdzie potrzeba praktycznego, nowoczesnego i energooszczędnego oświetlenia.

Dzięki zastosowaniu wydajnych diod LED typu COB marki **Citizen** oraz **Samsung** downlighty oferują wysoką skuteczność świetlną i wieloletni czas eksploatacji.

DAVELS



DOWNLIGHT LED

CZ: LED podsvícení / SK: LED podsvietenia/ EN: LED downlight

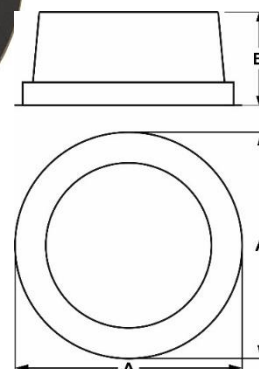

A

B

CITIZEN

	INDEX	ABC				Tc[K]	PF	LED		A [mm]	B [mm]	
A	013020	DAVELS LED	15 W	1500 lm	100 lm/W	4000 K	0,5	55°	Biały biła bielá white	110	60	5902216799516
A	013019	DAVELS LED	20 W	2000 lm	100 lm/W	4000 K	0,9	55°		127	70	5902808800002
A	013021	DAVELS LED	30 W	3000 lm	100 lm/W	4000 K	0,9	60°		165	80	5902216799530
B	007862	DAVELS LED	20 W	2000 lm	100 lm/W	4000 K	0,9	55°	Czarny Černá Čierná Black	127	70	5902808807797
B	013808	DAVELS LED	30 W	3000 lm	100 lm/W	2700 K	0,9	60°		164	80	5902808806738
B	013807	DAVELS LED	30 W	3000 lm	100 lm/W	4000 K	0,9	60°		164	80	5902808806745

AC 230V	COB LED	IP	
>90	44000 h	65	

Materiał / Materiál / Material
 PL: Aluminium, tworzywo sztuczne PC
 CZ: Hliník, PC Plast
 SK: Hliník PC Plast
 EN: Aluminum PC Plastic

**Optymalne warunki eksploatacji:
 Optimální provozní podmínky:
 Optimal operating conditions:**
 PL: temperatura.: od -25°C do +60°C
 wilgotność: <85% ciśnienie: 690-1060 hPa
 CZ: teplota: od -25°C do +60°C
 vlhkost: <85% tlak: 690-1060 hPa
 SK: teplota: od -25°C do +60°C
 vlhkost: <85% tlak: 690-1060 hPa
 EN: temperature: from -25°C do +60°C
 humidity: <85% pressure: 690-1060 hPa

Uwagi / Komentář / Komentáre
 PL: Zasilacz w komplecie
 CZ: Napájení je součástí dodávky
 SK: Napájanie je súčasťou dodávky
 EN: Power supply included



DAVELS



DOWNLIGHT LED

CZ: LED podsvícení / SK: LED podsvietenia/ EN: LED downlight

CITIZEN
LED



A



B

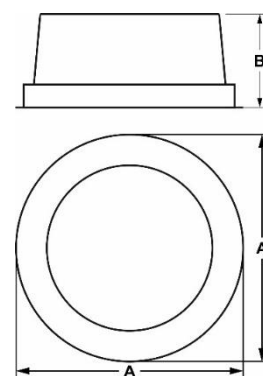

	INDEX	ABC				Tc[K]	PF			A [mm]	B [mm]	
A	013022	DAVELS LED	20 W	2000 lm	100 lm/W	4000 K	0,5	55°	Biały biła white	110	60	5902808807667
B	014002	DAVELS LED	20W	2000 lm	100 lm/W	2700 K	0,9	55°	Czarny Černá Čierná Black	110	60	5902808808367



AC 230V



COB LED



CRi(Ra)



>90 44000 h



IP



65



Materiał / Material / Material

PL: Aluminium, tworzywo sztuczne PC

CZ: Hliník, PC Plast

SK: Hliník PC Plast

EN: Aluminum PC Plastic

Optymalne warunki eksploatacji:

Optimální provozní podmínky:

Optimálne prevádzkové podmienky:

Optimal operating conditions:

PL: temperatura.: od -25°C do +60°C

wilgotność: <85% ciśnienie: 690-1060 hPa

CZ: teplota: od -25°C do +60°C

vlhkost: <85% tlak: 690-1060 hPa

SK: teplota: od -25°C do +60°C

vlhkost: <85% tlak: 690-1060 hPa

EN: temperature: from -25°C do +60°C

humidity: <85% pressure: 690-1060 hPa

Uwagi / Komentář / Komentáre

PL: Zasilacz w komplecie

CZ: Napájení je součástí dodávky

SK: Napájanie je súčasťou dodávky

EN: Power supply included

BroLux

DOWNLIGHT LED

CZ: LED podsvícení / SK: LED podsvietenia/ EN: LED downlight

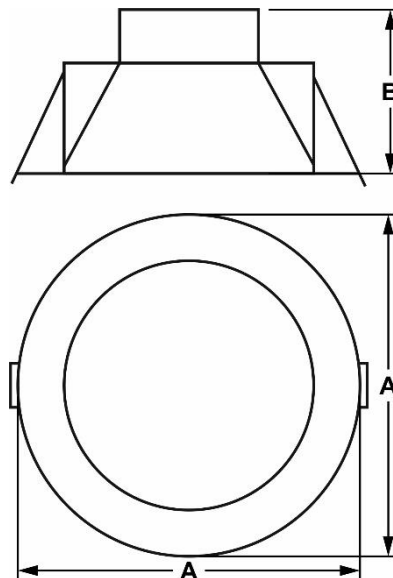

INDEX	ABC				Tc[K]		A [mm]	B [mm]	
012227	DINEL LED	4 W	400 lm	100 lm/W	3000 K	Biały biła Bielá white	82	50	5902216792562
012226	DINEL LED	4 W	400 lm	100 lm/W	4000 K		82	50	5902216792555
012229	DINEL LED	8 W	788 lm	98,5 lm/W	3000 K		113	56	5902216792586
012228	DINEL LED	8 W	788 lm	98,5 lm/W	4000 K		113	56	5902216792579

AC 230V	SMD LED	IP	100°
CRi(Ra)	PF	IP	PF
>80	40000 h	44	0,5

Uwagi / Komentář / Komentáre

PL: Zasilacz w komplecie

CZ: Napájení je součástí dodávky

SK: Napájanie je súčasťou dodávky

EN: Power supply included

Materiat / Material / Material

PL: Tworzywo sztuczne PC

CZ: PC Plast

SK: PC Plast

EN: PC Plastic

Optymalne warunki eksploatacji:

Optimální provozní podmínky:

Optimálne prevádzkové podmienky:

Optimal operating conditions:

PL: temperatura: od -25°C do +60°C

wilgotność: <85% ciśnienie: 690-1060 hPa

CZ: teplota: od -25°C do +60°C

vlhkost: <85% tlak: 690-1060 hPa

SK: teplota: od -25°C do +60°C

vlhkost: <85% tlak: 690-1060 hPa

EN: temperature: from -25°C to +60°C

humidity: <85% pressure: 690-1060 hPa

ROWANA



DOWNLIGHT LED

CZ: LED podsvícení / SK: LED podsvietenia/ EN: LED downlight

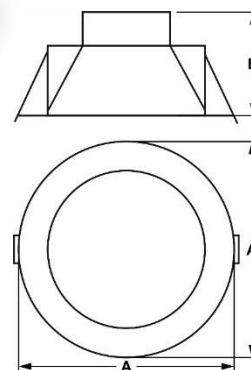

INDEX	ABC			Tc[K]			A [mm]	B [mm]	
006277	Rowana LED	5W	420-450 lm	3000K	Biały Bielá white	45°	90	75	5902216789333
004832	Rowana LED	5W	420-450 lm	4500K		45°	90	75	5902216781177
006278	Rowana LED	10W	900-950 lm	3000K		45°	110	85	5902216789340
004837	Rowana LED	10W	900-950 lm	4500K		45°	110	85	5902216781184
006279	Rowana LED	15W	1350-1400 lm	3000K		45°	138	105	5902216789357
004840	Rowana LED	15W	1350-1400 lm	4500K		45°	138	105	5902216781191
006280	Rowana LED	20W	1730-1780 lm	3000K		45°	138	105	5902216781207
004860	Rowana LED	20W	1730-1780 lm	4500K		45°	138	105	5902216781214
006281	Rowana LED	30W	2550-2600 lm	3000K		60°	160	120	5902216789364
004864	Rowana LED	30W	2550-2600 lm	4500K		60°	160	120	5902216781221

AC 230V	COB	
CRI(Ra)	IP	
>80	40000 h	20
CE	RoHS COMPLIANT	

Materiał / Materiál / Material

PL: aluminium

CZ: hliník

SK: hliník

EN: aluminum

Optymalne warunki eksploatacji:

Optimální provozní podmínky:

Optimálne prevádzkové podmienky:

Optimal operating conditions:

PL: temperatura.: od -25°C do +60°C

wilgotność: <85% ciśnienie: 690-1060 hPa

CZ: teplota: od -25°C do +60°C

vlhkost: <85% tlak: 690-1060 hPa

SK: teplota: od -25°C do +60°C

vlhkost: <85% tlak: 690-1060 hPa

EN: temperature: from -25°C to +60°C

humidity: <85% pressure: 690-1060 hPa

Uwagi / Komentář / Komentáre

PL: Zasilacz w komplecie

CZ: Napájení je součástí dodávky

SK: Napájanie je súčasťou dodávky

EN: Power supply included

BroLux

GIMBAL



DOWNLIGHT LED

CZ: LED podsvícení / SK: LED podsvietenia/ EN: LED downlight

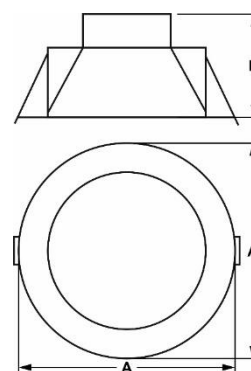

INDEX	ABC		Tc[K]		PF		A [mm]	B [mm]	
008169	Gimbal LED	60W	4500K	5850lm	≥0.95	Biały biła Bielá white	250	145	5902216781351
008198	Gimbal LED	50W	4500K	4850lm	≥0.95		250	145	5902216781375
003146	Gimbal LED	50W	3000K	4800lm	≥0.95		250	145	5902216781368
008704	Gimbal LED	50W	6500K	5000lm	≥0.95		250	145	5902216781382

AC 230V	SMD LED	60°	
>80	40000 h	20	

Uwagi / Komentář / Komentáre

PL: Zasilacz w komplecie

CZ: Napájení je součástí dodávky

SK: Napájanie je súčasťou dodávky

EN: Power supply included

Materiał / Materiál / Material

PL: aluminium

CZ: hliník

SK: hliník

EN: aluminum

Optymalne warunki eksploatacji:

Optimální provozní podmínky:

Optimálne prevádzkové podmienky:

Optimal operating conditions:

PL: temperatura.: od -25°C do +60°C

wilgotność: <85% ciśnienie: 690-1060 hPa

CZ: teplota: od -25°C do +60°C

vlhkost: <85% tlak: 690-1060 hPa

SK: teplota: od -25°C do +60°C

vlhkost: <85% tlak: 690-1060 hPa

EN: temperature: from -25°C to +60°C

humidity: <85% pressure: 690-1060 hPa



GRIPEN



DOWNLIGHT LED

CZ: LED podsvícení / SK: LED podsvietenia/ EN: LED downlight

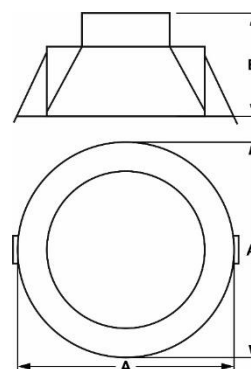

INDEX	ABC		Tc[K]	Lm	PF		A [mm]	B [mm]	
008816	GRIPEN LED	28W	4500K	2800lm	≥0.95	Biały biela Bielá white	195	120	5902216781344
008222	GRIPEN LED	38W	4500K	3500lm	≥0.95		195	175	5902216781337

AC 230V	SMD LED	60°	
CRI(Ra) >80	40000 h	IP 20	

Materiał / Materiál / Material

PL: aluminium

CZ: hliník

SK: hliník

EN: aluminum

Optymalne warunki eksploatacji:

Optimální provozní podmínky:

Optimálne prevádzkové podmienky:

Optimal operating conditions:

PL: temperatura.: od -25°C do +60°C

wilgotność: <85% ciśnienie: 690-1060 hPa

CZ: teplota: od -25°C do +60°C

vlhkost: <85% tlak: 690-1060 hPa

SK: teplota: od -25°C do +60°C

vlhkost: <85% tlak: 690-1060 hPa

EN: temperature: from -25°C to +60°C

humidity: <85% pressure: 690-1060 hPa

Uwagi / Komentár / Komentáre

PL: Zasilacz w komplecie

CZ: Napájení je součástí dodávky

SK: Napájanie je súčasťou dodávky

EN: Power supply included

BroLux

SHINY



DOWNLIGHT LED

CZ: LED podsvícení / SK: LED podsvietenia/ EN: LED downlight

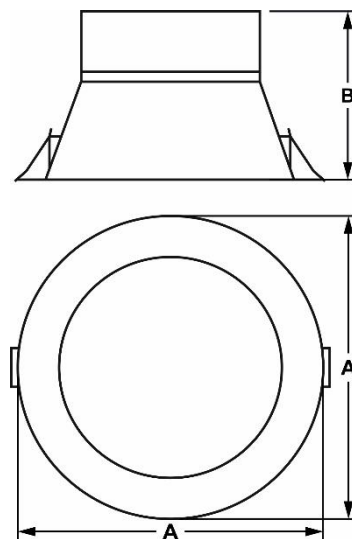

INDEX	ABC				Tc[K]		A [mm]	B [mm]	
012820	SHINY LED	10 W	800 lm	80 lm/W	4000 K	Biały biła bielá white	135	70	5902216797857
012821	SHINY LED	18 W	1440 lm	80 lm/W	4000 K		182	83	5902216797864
013316	SHINY LED	30 W	2400 lm	80 lm/W	4000 K		220	100	5902808803966

AC 230V	COB LED	IP	90°
CRi(Ra)	40000 h	PF	
>80	44	0.9	

Uwagi / Komentář / Komentáre

PL: Zasilacz w komplecie

CZ: Napájení je součástí dodávky

SK: Napájanie je súčasťou dodávky

EN: Power supply included

Materiał / Materiál / Material

PL: Tworzywo sztuczne PC

CZ: PC Plast

SK: PC Plast

EN: PC Plastic

Optymalne warunki eksploatacji:

Optimální provozní podmínky:

Optimálne prevádzkové podmienky:

Optimal operating conditions:

PL: temperatura.: od -25°C do +60°C

wilgotność: <85% ciśnienie: 690-1060 hPa

CZ: teplota: od -25°C do +60°C

vlhkost: <85% tlak: 690-1060 hPa

SK: teplota: od -25°C do +60°C

vlhkost: <85% tlak: 690-1060 hPa

EN: temperature: from -25°C do +60°C

humidity: <85% pressure: 690-1060 hPa

Brolux

DOWNLIGHT LED

CZ: LED podsvícení / SK: LED podsvietenia/ EN: LED downlight



INDEX	ABC →		Tc[K]	Lm			A [mm]	B [mm]	
013623	Tilly LED	30W	3000K	3000 lm	24°	Biały biła Bielá white	165	128	5902808804222
012310	Tilly LED	30W	4000 K	3000 lm	24°	Czarny Černá Čierná Black	165	128	5902216793316
013626	Tilly LED	30W	4000K	3000 lm	24°	Biały biła Bielá white	165	128	5902808804239
013625	Tilly LED	50W	3000K	5000 lm	38°	Biały biła Bielá white	188	154	5902808804246
013624	Tilly LED	50W	4000K	5000 lm	38°	Biały biła Bielá white	188	154	5902808804253

		PF	
AC 230V	SMD LED		
		IP	
>80	40000 h	20	
	CE	RoHS COMPLIANT	

Uwagi / Komentář / Komentáre

PL: Zasilacz w komplecie

CZ: Napájení je součástí dodávky

SK: Napájanie je súčasťou dodávky

EN: Power supply included

Materiał / Materiál / Material

PL: aluminium

CZ: hliník

SK: hliník

EN: aluminum

Optymalne warunki eksploatacji:

Optimální provozní podmínky:

Optimálne prevádzkové podmienky:

Optimal operating conditions:

PL: temperatura.: od -25°C do +60°C

wilgotność: <85% ciśnienie: 690-1060 hPa

CZ: teplota: od -25°C do +60°C

vlhkost: <85% tlak: 690-1060 hPa

SK: teplota: od -25°C do +60°C

vlhkost: <85% tlak: 690-1060 hPa

EN: temperature: from -25°C to +60°C

humidity: <85% pressure: 690-1060 hPa

TILLY DALI



DOWNLIGHT LED

CZ: LED podsvícení / SK: LED podsvietenia/ EN: LED downlight



INDEX	ABC		Tc[K]	Lm			A [mm]	B [mm]	
013760	Tilly LED	30W	3000K	3000 lm	24°	Biały bílá Bielá white	165	128	5902808805571

		PF	
AC 230V	SMD LED		
		IP	
CR I(Ra)	40000 h	20	
>80			
	CE	RoHS COMPLIANT	

Uwagi / Komentář / Komentáre

PL: Zasilacz w komplecie

CZ: Napájení je součástí dodávky

SK: Napájanie je súčasťou dodávky

EN: Power supply included

Materiał / Materiál / Material

PL: aluminium

CZ: hliník

SK: hliník

EN: aluminum

Optymalne warunki eksploatacji:

Optimální provozní podmínky:

Optimálne prevádzkové podmienky:

Optimal operating conditions:

PL: temperatura.: od -25°C do +60°C

wilgotność: <85% ciśnienie: 690-1060 hPa

CZ: teplota: od -25°C do +60°C

vlhkost: <85% tlak: 690-1060 hPa

SK: teplota: od -25°C do +60°C

vlhkost: <85% tlak: 690-1060 hPa

EN: temperature: from -25°C to +60°C

humidity: <85% pressure: 690-1060 hPa

BroLux

XENA



DOWNLIGHT LED

CZ: LED podsvícení / SK: LED podsvietenia/ EN: LED downlight

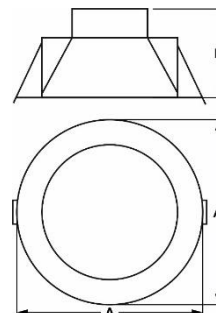

INDEX	ABC						A [mm]	B [mm]	
045606	Xena LED	7W	100lm/W	700lm	4000K	Biały biłá biely white	92	55	5902808809654
045605	Xena LED	15W	100lm/W	1500lm	4000K		140	65	5902808809661
045604	Xena LED	20W	100lm/W	2000lm	4000K		170	65	5902808809678
013971	Xena LED	30W	100lm/W	3000lm	4000K		235	90	5902808809692
045607	Xena LED	20W	100lm/W	2000lm	4000K	Czarny Černá Čierny Black	170	65	5902808809685

AC 230V	SMD LED	IP	100°
CRI(Ra)	40000 h	PF	
>80	44	0,5	

Uwagi / Komentář / Komentáre

PL: Zasilacz w komplecie

CZ: Napájení je součástí dodávky

SK: Napájanie je súčasťou dodávky

EN: Power supply included

Materiał / Materiál / Material

PL: Tworzywo sztuczne PC

CZ: PC Plast

SK: PC Plast

EN: PC Plastic

Optymalne warunki eksploatacji:
Optimální provozní podmínky:
Optimálne prevádzkové podmienky:
Optimal operating conditions:

PL: temperatura.: od -10°C do +25°C

wilgotność: <85% ciśnienie: 690-1060 hPa

CZ: teplota: od -10 ° C do + 25 ° C

vlhkost: <85% tlak: 690-1060 hPa

SK: teplota: od -10 ° C do + 25 ° C

vlhkost: <85% tlak: 690-1060 hPa

EN: temperature: from -10 ° C to + 25 ° C

humidity: <85% pressure: 690-1060 hPa



DOWNLIGHT LED

CZ: LED podsvícení / SK: LED podsvietenia/ EN: LED downlight



INDEX	ABC		Tc[K]	Lm			A [mm]	B [mm]	
013761	KARIM	12W	3000K	lm	24°	Bílý bílá Bielá white			5902808805588

		PF	
AC 230V	SMD LED		
		IP	
CRi(Ra)			
>90	40000 h	20	

Uwagi / Komentář / Komentáre

PL: Zasilacz w komplecie

CZ: Napájení je součástí dodávky

SK: Napájanie je súčasťou dodávky

EN: Power supply included

Materiał / Materiál / Material

PL: aluminium

CZ: hliník

SK: hliník

EN: aluminum

Optymalne warunki eksploatacji:

Optimální provozní podmínky:

Optimálne prevádzkové podmienky:

Optimal operating conditions:

PL: temperatura.: od -25°C do +60°C

wilgotność: <85% ciśnienie: 690-1060 hPa

CZ: teplota: od -25°C do +60°C

vlhkost: <85% tlak: 690-1060 hPa

SK: teplota: od -25°C do +60°C

vlhkost: <85% tlak: 690-1060 hPa

EN: temperature: from -25°C to +60°C

humidity: <85% pressure: 690-1060 hPa

BOREM



DOWNLIGHT LED

CZ: LED podsvícení / SK: LED podsvietenia/ EN: LED downlight

PHILIPS LED



INDEX	ABC		Tc[K]				A [mm]	B [mm]	
013762	Borem	10W	3000K		24°	Bílý bílá Bielá white			5902808805649

		PF	
AC 230V	SMD LED		
		IP	
CR1(Ra)	40000 h	20	
>90			

Uwagi / Komentář / Komentáre

PL: Zasilacz w komplecie

CZ: Napájení je součástí dodávky

SK: Napájanie je súčasťou dodávky

EN: Power supply included

Materiał / Materiál / Material

PL: aluminium

CZ: hliník

SK: hliník

EN: aluminum

Optymalne warunki eksploatacji:

Optimální provozní podmínky:

Optimálne prevádzkové podmienky:

Optimal operating conditions:

PL: temperatura.: od -25°C do +60°C

wilgotność: <85% ciśnienie: 690-1060 hPa

CZ: teplota: od -25°C do +60°C

vlhkost: <85% tlak: 690-1060 hPa

SK: teplota: od -25°C do +60°C

vlhkost: <85% tlak: 690-1060 hPa

EN: temperature: from -25°C to +60°C

humidity: <85% pressure: 690-1060 hPa

www.bowi.com.pl

DOWNLIGHT LED

CZ: LED podsvícení / SK: LED podsvietenia/ EN: LED downlight



A



B

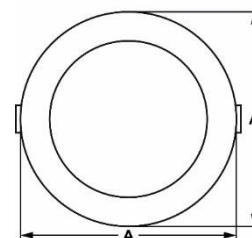
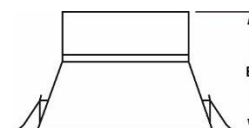

	INDEX	ABC			Tc[K]		A [mm]	B [mm]	
A	011103	KAREL LED	20W	90 lm/W	2700K	Biały biłá bielá white	225	35	5902216781498
A	012570	KAREL LED	20W	90 lm/W	4000K		225	35	5902216796621
A	004943	KAREL LED	30W	90 lm/W	2700K		225	35	5902808808466
A	007139	KAREL LED	30W	90 lm/W	4000K		225	35	5902808808473
B	011102	KAREL LED	20W	90 lm/W	4000K	Czarny Černá Čierná Black	225	35	5902216783157
B	002249	KAREL LED	30W	90 lm/W	4000K		225	35	5902808808480



AC 230V



COB



110°



IP



≥ 80



40000 h



44



Materiał / Materiál / Material

PL: aluminium

CZ: hliník

SK: hliník

EN: aluminum

Uwagi / Komentář / Komentáre

PL: Zasilacz w komplecie

CZ: Napájení je součástí dodávky

SK: Napájanie je súčasťou dodávky

EN: Power supply included

PERCI



DOWNLIGHT LED

CZ: LED podsvícení / SK: LED podsvietenia/ EN: LED downlight



A



B

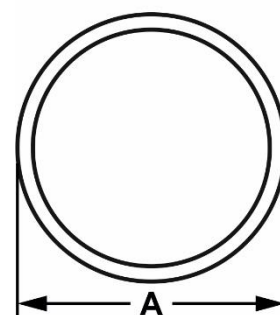

	INDEX	ABC	20W	90 lm/W	Tc[K]		A [mm]	B [mm]	
A	006285	PERCI LED	20W	90 lm/W	2700K	Biały biłá bielá white	147	80	5902216789296
A	009425	PERCI LED	20W	90 lm/W	4000K		147	80	5902216789272
A	011106	PERCI LED	30W	90 lm/W	2700K		167	90	5902808808497
A	011104	PERCI LED	30W	90 lm/W	4000K		167	90	5902216732599
B	006222	PERCI LED	20W	90 lm/W	4000K	Czarny Černá Čierná Black	147	80	5902216789371
B	011105	PERCI LED	30W	90 lm/W	4000K		167	90	5902808808503

AC 230V	COB	120°	IP
≥ 80	40000 h	40	RoHS COMPLIANT

Materiał / Materiál / Material

PL: aluminium

CZ: hliník

SK: hliník

EN: aluminum

Uwagi / Komentář / Komentáre

PL: Zasilacz w komplecie

CZ: Napájení je součástí dodávky

SK: Napájanie je súčasťou dodávky

EN: Power supply included

Br**o**lux

TRIAD

DOWNLIGHT LED

CZ: LED podsvícení / SK: LED podsvietenia/ EN: LED downlight

CITIZEN

LED



INDEX	ABC		Tc[K]		PF		A [mm]	B [mm]	
013862	Triad	20W	4000K	100 lm/W	0,9	Czarny Černá Čierna Black	95	152	5902808807803
009510	Triad	40W	4000 K	100 lm/W	0,9	Biały bílá Bielá white	140	162	5902216711785

AC 230V	SMD LED	45°	IP
>90	40000 h	65	RoHS COMPLIANT

Uwagi / Komentář / Komentáre

PL: Zasilacz w komplecie

CZ: Napájení je součástí dodávky

SK: Napájanie je súčasťou dodávky

EN: Power supply included

Materiał / Materiál / Material

PL: aluminium

CZ: hliník

SK: hliník

EN: aluminum

Optymalne warunki eksploatacji:

Optimální provozní podmínky:

Optimálne prevádzkové podmienky:

Optimal operating conditions:

PL: temperatura.: od -25°C do +60°C

wilgotność: <85% ciśnienie: 690-1060 hPa

CZ: teplota: od -25°C do +60°C

vlhkost: <85% tlak: 690-1060 hPa

SK: teplota: od -25°C do +60°C

vlhkost: <85% tlak: 690-1060 hPa

EN: temperature: from -25°C to +60°C

humidity: <85% pressure: 690-1060 hPa

Brolux



PANELE LED

Panele LED idealnie pasują do wszelkich wnętrz, w szczególności zastosowanie znajdują w pomieszczeniach biurowych. Elegancki design, cienka obudowa i równomierny strumień światła sprawiają, że panele LED są częstym wyborem projektantów oświetlenia w wielu aranżacjach wnętrz. Brak efektu olśnienia w panelach LED zapewnia łagodne i bezpieczne dla oczu światło. Możliwość podłączenia kontrolerów DALI pozwala na regulację jasności i sterowanie oświetleniem.

PANELE LED

CZ: LED panely/ SK: LED panely/ EN: LED panel

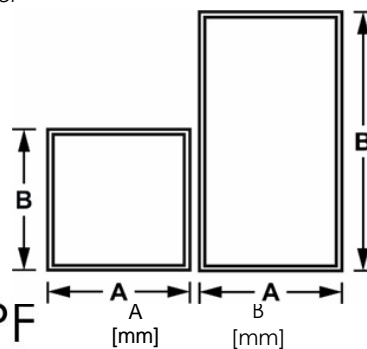

INDEX	ABC	AC 230V	SMD LED	120°	CRI(Ra)	>80	40000 h	20	CE	RoHS COMPLIANT	PF	A [mm]	B [mm]	Barcode
012934	Timan LED	32 W	2560 lm	80 lm/W	4000 K						>0.9	595	595	5902216798915
005936	Timan LED	40 W	3803 lm	95 lm/W	3000 K						>0.9	595	595	5902216709560
005937	Timan LED	40 W	3803 lm	95 lm/W	4000 K						>0.9	595	595	5902216709553
012053	Timan LED	40 W	3479 lm	87 lm/W	4000 K						>0.9	295	1195	5902216791473
011328	Timan LED	40 W	3200 lm	80 lm/W	4500 K						>0.9	595	595	5902216708150
009658	Timan LED	40 W	3200 lm	80 lm/W	6000 K						>0.9	595	595	5902216793361
012346	Timan LED	40 W	3200 lm	80 lm/W	6000 K						>0.9	295	1195	5902216794764
012373	Timan LED	40 W	4000 lm	100 lm/W	4000 K						>0.9	595	595	5902216794771
012388	Timan LED	40 W	4000 lm	100 lm/W	4000 K						>0.9	295	1195	5902216794832
012449	Timan LED	40 W	4800 lm	120 lm/W	4000 K						>0.9	595	595	5902216795495
004987	Timan LED	48 W	4200 lm	87 lm/W	3000 K						>0.9	295	1195	5902216709515
002604	Timan LED	48 W	4200 lm	87 lm/W	3000 K						>0.9	620	620	5902216709713
003486	Timan LED	48 W	4200 lm	87 lm/W	3000 K						>0.9	625	625	5902216709720
1066	Timan LED	48 W	4200 lm	87 lm/W	3000 K						>0.9	295	1195	5902216709584
005094	Timan LED	48 W	4200 lm	87 lm/W	4500 K						>0.9	295	1195	5902216709508
5361	Timan LED	48 W	4450 lm	93 lm/W	4000 K						>0.9	595	595	5902216709577
003782	Timan LED	48 W	4200 lm	87 lm/W	4500 K						>0.9	595	595	5902216765740
009621	Timan LED	48 W	4200 lm	87 lm/W	4500 K						>0.9	620	620	5902216709683
009571	Timan LED	48 W	4200 lm	87 lm/W	4500 K						>0.9	625	625	5902216709690
009659	Timan LED	48 W	4200 lm	87 lm/W	6500 K						>0.9	595	595	5902216793378
012374	Timan LED	48 W	4800 lm	100 lm/W	4000 K						>0.9	595	595	5902216794788
006027	Timan LED	60 W	5200 lm	87 lm/W	3000 K						>0.9	295	1195	5902216709539
002667	Timan LED	60 W	5200 lm	87 lm/W	3000 K						>0.9	595	595	5902216709607
005939	Timan LED	60 W	5200 lm	87 lm/W	4000 K						>0.9	295	1195	5902216709522
012360	Timan LED	60 W	5200 lm	87 lm/W	4000 K						>0.9	595	595	5902216794795
1183	Timan LED	60 W	5200 lm	87 lm/W	4500 K						>0.9	595	595	5902216709591
012361	Timan LED	60 W	5200 lm	87 lm/W	6500 K						>0.9	595	595	5902216794801
011832	Timan LED	70 W	6727 lm	96 lm/W	4000 K						>0.9	595	1195	5902808800941

Biały
biłá
biela
white

AC 230V
 SMD LED
 120°
 CRI(Ra)
 >80
 40000 h
 20
 IP
 CE
 RoHS COMPLIANT

Uwagi / Komentář / Komentáre
 PL: Zasilacz w komplecie
 CZ: Napájení je součástí dodávky
 SK: Napájanie je súčasťou dodávky
 EN: Power supply included

Materiál / Material / Material
 PL: aluminium
 CZ: hliník
 SK: hliník
 EN: aluminum
 Optymalne warunki eksploatacji:
 Optimální provozní podmínky:
 Optimálne prevádzkové podmienky:
 Optimal operating conditions:
 PL: temperatura.: od -25°C do +60°C
 wilgotność: <85% ciśnienie: 690-1060 hPa
 CZ: teplota: od -25°C do +60°C
 vlhkost: <85% tlak: 690-1060 hPa
 SK: teplota: od -25°C do +60°C
 vlhkost: <85% tlak: 690-1060 hPa
 EN: temperature: from -25°C to +60°C
 humidity: <85% pressure: 690-1060 hPa



TIMAN RA>90



PANELE LED

CZ: LED panely/ SK: LED panely/ EN: LED panel

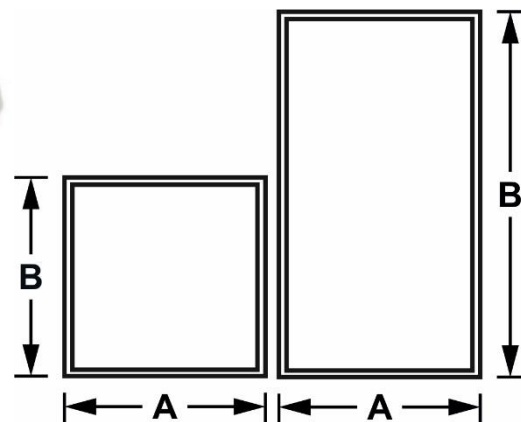

INDEX	ABC				Tc[K]	PF		A [mm]	B [mm]	
012450	Timan LED	40W	3915 lm	98lm/W	4000K	>0.9	Biały biła bielá white	595	595	5902216795501

AC 230V	SMD LED	120°	
>90	40000 h	20	

Uwagi / Komentář / Komentáre

PL: Zasilacz w komplecie

CZ: Napájení je součástí dodávky

SK: Napájanie je súčasťou dodávky

EN: Power supply included

Materiał / Materiál / Material

PL: aluminium

CZ: hliník

SK: hliník

EN: aluminum

Optymalne warunki eksploatacji:

Optimální provozní podmínky:

Optimálne prevádzkové podmienky:

Optimal operating conditions:

PL: temperatura.: od -25°C do +60°C

wilgotność: <85% ciśnienie: 690-1060 hPa

CZ: teplota: od -25°C do +60°C

vlhkost: <85% tlak: 690-1060 hPa

SK: teplota: od -25°C do +60°C

vlhkost: <85% tlak: 690-1060 hPa

EN: temperature: from -25°C to +60°C

humidity: <85% pressure: 690-1060 hPa

Br^olux

PANELE LED

CZ: LED panely/ SK: LED panely/ EN: LED panel

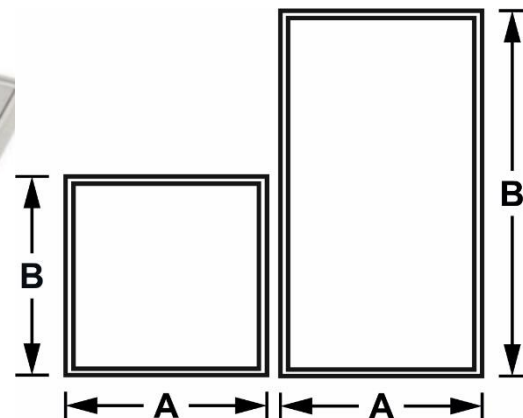

INDEX	ABC					PF		A [mm]	B [mm]	
012261	Timan LED	40W	4000 lm	100lm/W	4000K	>0.9	Biały biła bielá white	595	595	590221 6792814

AC 230V	SMD LED	120°	
>90	40000 h	20	

Uwagi / Komentář / Komentáre

PL: Zasilacz w komplecie

CZ: Napájení je součástí dodávky

SK: Napájanie je súčasťou dodávky

EN: Power supply included

Materiał / Materiál / Material

PL: aluminium

CZ: hliník

SK: hliník

EN: aluminum

Optymalne warunki eksploatacji:

Optimální provozní podmínky:

Optimálne prevádzkové podmienky:

Optimal operating conditions:

PL: temperatura.: od -25°C do +60°C

wilgotność: <85% ciśnienie: 690-1060 hPa

CZ: teplota: od -25°C do +60°C

vlhkosť: <85% tlak: 690-1060 hPa

SK: teplota: od -25°C do +60°C

vlhkosť: <85% tlak: 690-1060 hPa

EN: temperature: from -25°C to +60°C

humidity: <85% pressure: 690-1060 hPa

TIMAN PQ



PANELE LED

CZ: LED panely/ SK: LED panely/ EN: LED panel

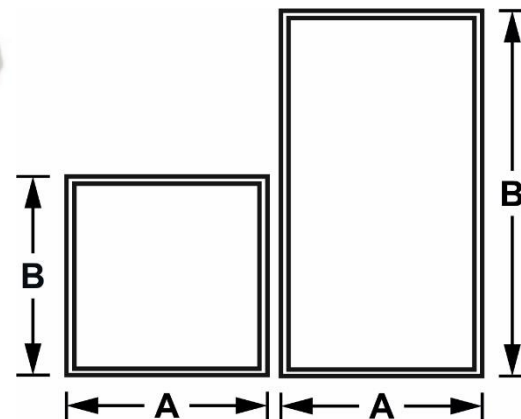

INDEX	ABC						Tc[K]	PF		A [mm]	B [mm]	
012287	Timan LED	48 W	4800 lm	100lm/W	4000 K	0,9	Biały biła bielá white		295	1195	5902216798885	
012935	Timan LED	32 W	3840 lm	120 lm/W	4000 K	0,9			595	595	5902216798908	
012567	Timan LED	40 W	4400 lm	110 lm/W	3000 K	0,9			595	595	5902216796614	
012563	Timan LED	40 W	4400 lm	110 lm/W	4000 K	0,9			595	595	5902216796607	
005938	Timan LED	70 W	7700 lm	110 lm/W	4000 K	0,9			595	1195	5902216709546	

AC 230V	SMD LED	120°	
>80	40000 h	20	

Uwagi / Komentář / Komentáre

PL: Zasilacz w komplecie

CZ: Napájení je součástí dodávky

SK: Napájanie je súčasťou dodávky

EN: Power supply included

Materiał / Materiál / Material

PL: aluminium

CZ: hliník

SK: hliník

EN: aluminum

Optymalne warunki eksploatacji:

Optimální provozní podmínky:

Optimálne prevádzkové podmienky:

Optimal operating conditions:

PL: temperatura.: od -25°C do +60°C

wilgotność: <85% ciśnienie: 690-1060 hPa

CZ: teplota: od -25°C do +60°C

vlhkost: <85% tlak: 690-1060 hPa

SK: teplota: od -25°C do +60°C

vlhkosť: <85% tlak: 690-1060 hPa

EN: temperature: from -25°C to +60°C

humidity: <85% pressure: 690-1060 hPa

Brolux

TIMAN PQ UGR<19



PANELE LED

CZ: LED panely/ SK: LED panely/ EN: LED panel

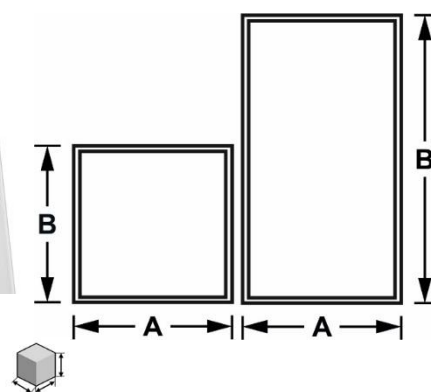

INDEX	ABC				Tc[K]	PF		A [mm]	B [mm]	
013143	Timan LED	40W	4159 lm	104 lm/W	3000K	>0.9	Biały bílá bielá white	595	595	5902808800965
012819	Timan LED	40W	4320 lm	108 lm/W	4000K	>0.9		595	595	5902216797659
5759	Timan LED	48W	5760 lm	120 lm/W	4000K	>0.9		595	595	5902808807353
013287	Timan LED	70W	7048 lm	101 lm/W	4000K	>0.9		595	1195	5902808800958



AC 230V

SMD LED

120°



80

40000 h

20



Materiał / Materiál / Material

PL: aluminium

CZ: hliník

SK: hliník

EN: aluminum

Optymalne warunki eksploatacji:

Optimální provozní podmínky:

Optimálne prevádzkové podmienky:

Optimal operating conditions:

PL: temperatura.: od -25°C do +60°C

wilgotność: <85% ciśnienie: 690-1060 hPa

CZ: teplota: od -25°C do +60°C

vlhkost: <85% tlak: 690-1060 hPa

SK: teplota: od -25°C do +60°C

vlhkost: <85% tlak: 690-1060 hPa

EN: temperature: from -25°C to +60°C

humidity: <85% pressure: 690-1060 hPa

Uwagi / Komentář / Komentáre

PL: Zasilacz w komplecie

CZ: Napájení je součástí dodávky

SK: Napájanie je súčasťou dodávky

EN: Power supply included



www.bowi.com.pl

TIMAN PQ IP65



PANELE LED

CZ: LED panely/ SK: LED panely/ EN: LED panel

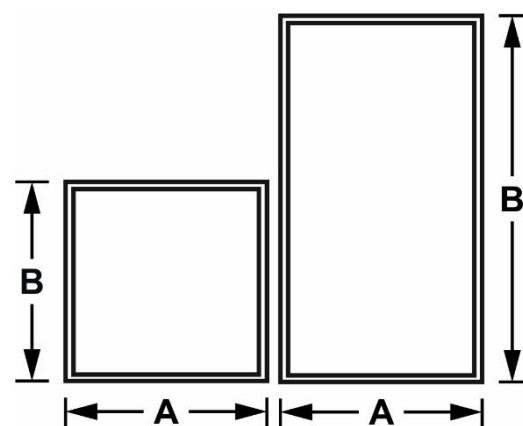

INDEX	ABC				Tc[K]	PF		A [mm]	B [mm]	
012590	Timan LED	40W	4800 lm	120 lm/W	4000K	>0.9		595	595	5902216796867

AC 230V	SMD LED	120°	
80	40000 h	65	

Uwagi / Komentář / Komentáre

PL: Zasilacz w komplecie

CZ: Napájení je součástí dodávky

SK: Napájanie je súčasťou dodávky

EN: Power supply included

Materiał / Materiál / Material

PL: aluminium

CZ: hliník

SK: hliník

EN: aluminum

Optymalne warunki eksploatacji:

Optimální provozní podmínky:

Optimálne prevádzkové podmienky:

Optimal operating conditions:

PL: temperatura.: od -25°C do +60°C

wilgotność: <85% ciśnienie: 690-1060 hPa

CZ: teplota: od -25°C do +60°C

vlhkost: <85% tlak: 690-1060 hPa

SK: teplota: od -25°C do +60°C

vlhkosť: <85% tlak: 690-1060 hPa

EN: temperature: from -25°C to +60°C

humidity: <85% pressure: 690-1060 hPa

BroLux

TIMAN PQ RA>90



PANELE LED

CZ: LED panely/ SK: LED panely/ EN: LED panel

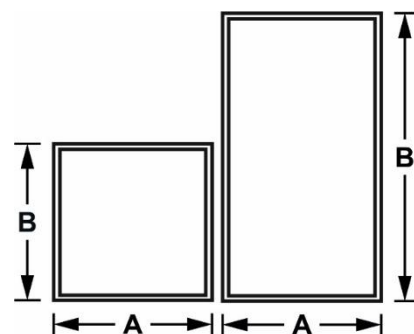

INDEX	ABC				Tc[K]	PF		A [mm]		B [mm]	
012936	Timan LED	40W	3200 lm	80 lm/W	4000K	>0.9	Biały biła white	595	595	595	5902216798892

AC 230V	SMD LED	120°	IP
CRI/Ra	40000 h	20	
>90			
RoHS COMPLIANT	CE	RoHS COMPLIANT	

Uwagi / Komentář / Komentáre

PL: Zasilacz w komplecie

CZ: Napájení je součástí dodávky

SK: Napájanie je súčasťou dodávky

EN: Power supply included

Materiał / Materiál / Material

PL: aluminium

CZ: hliník

SK: hliník

EN: aluminum

Optymalne warunki eksploatacji:

Optimální provozní podmínky:

Optimálne prevádzkové podmienky:

Optimal operating conditions:

PL: temperatura.: od -25°C do +60°C

wilgotność: <85% ciśnienie: 690-1060 hPa

CZ: teplota: od -25°C do +60°C

vlhkost: <85% tlak: 690-1060 hPa

SK: teplota: od -25°C do +60°C

vlhkost: <85% tlak: 690-1060 hPa

EN: temperature: from -25°C to +60°C

humidity: <85% pressure: 690-1060 hPa

Brolux

TIMAN PQ DALI



PANELE LED

CZ: LED panely/ SK: LED panely/ EN: LED panel

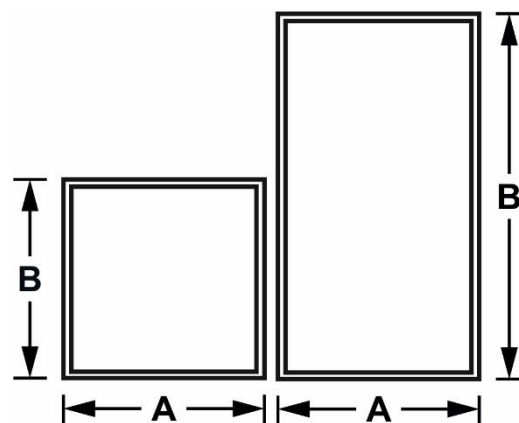

INDEX	ABC											
		AC 230V	SMD LED	120°	DALI	CR(I)Ra	40000 h	IP				
013030	Timan LED	40 W	4000 lm	100lm/W	4000 K	0,9						
013032	Timan LED	48 W	4800 lm	110lm/W	4000 K	0,9						



AC 230V

SMD LED

120°

DALI



>80

40000 h

20



Materiał / Materiál / Material

PL: aluminium

CZ: hliník

SK: hliník

EN: aluminum

Optymalne warunki eksploatacji:

Optimální provozní podmínky:

Optimálne prevádzkové podmienky:

Optimal operating conditions:

PL: temperatura.: od -25°C do +60°C

wilgotność: <85% ciśnienie: 690-1060 hPa

CZ: teplota: od -25°C do +60°C

vlhkost: <85% tlak: 690-1060 hPa

SK: teplota: od -25°C do +60°C

vlhkost: <85% tlak: 690-1060 hPa

EN: temperature: from -25°C to +60°C

humidity: <85% pressure: 690-1060 hPa

Uwagi / Komentář / Komentáre

PL: Zasilacz w komplecie

CZ: Napájení je součástí dodávky

SK: Napájanie je súčasťou dodávky

EN: Power supply included

Br^olux

www.bowi.com.pl

TIMAN IP65 UGR<19



PANELE LED

CZ: LED panely/ SK: LED panely/ EN: LED panel

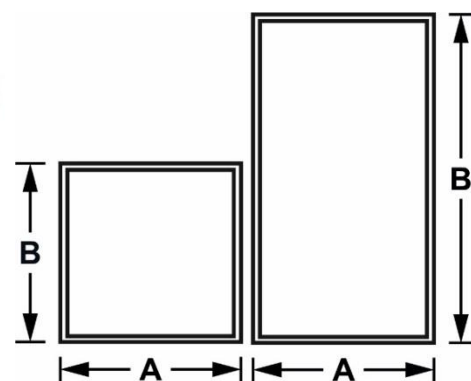

INDEX	ABC		Lm	Lm	Tc[K]	PF		A [mm]	B [mm]	
006438	Timan LED	40 W	4000 lm	100lm/W	4000 K	0.9	Biały bílá bielá white	595	595	5902808803997

AC 230V	SMD LED	90°	
>80	40000 h	65	

Uwagi / Komentář / Komentáre

PL: Zasilacz w komplecie

CZ: Napájení je součástí dodávky

SK: Napájanie je súčasťou dodávky

EN: Power supply included

Materiał / Materiál / Material

PL: aluminium

CZ: hliník

SK: hliník

EN: aluminum

Optymalne warunki eksploatacji:

Optimální provozní podmínky:

Optimálne prevádzkové podmienky:

Optimal operating conditions:

PL: temperatura.: od -25°C do +60°C

wilgotność: <85% ciśnienie: 690-1060 hPa

CZ: teplota: od -25°C do +60°C

vlhkost: <85% tlak: 690-1060 hPa

SK: teplota: od -25°C do +60°C

vlhkost: <85% tlak: 690-1060 hPa

EN: temperature: from -25°C to +60°C

humidity: <85% pressure: 690-1060 hPa

BroLux

TIMAN PQ UGR<19 RA>90

PANELE LED

CZ: LED panely/ SK: LED panely/ EN: LED panel



SAMSUNG
LED

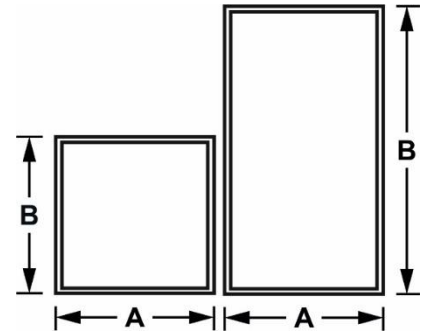

INDEX	ABC				Tc[K]	PF		A [mm]		B [mm]	
013279	Timan LED	40W	4160 lm	104 lm/W	4000K	>0.9	Biały bílá white	595		595	5902808800989

AC 230V	SMD LED	120°	IP
CRI/Ra	40000 h	20	
>90			
RoHS COMPLIANT	CE	RoHS COMPLIANT	

Uwagi / Komentář / Komentáre

PL: Zasilacz w komplecie

CZ: Napájení je součástí dodávky

SK: Napájanie je súčasťou dodávky

EN: Power supply included

Materiał / Materiál / Material

PL: aluminium

CZ: hliník

SK: hliník

EN: aluminum

Optymalne warunki eksploatacji:

Optimální provozní podmínky:

Optimálne prevádzkové podmienky:

Optimal operating conditions:

PL: temperatura.: od -25°C do +60°C

wilgotność: <85% ciśnienie: 690-1060 hPa

CZ: teplota: od -25°C do +60°C

vlhkost: <85% tlak: 690-1060 hPa

SK: teplota: od -25°C do +60°C

vlhkost: <85% tlak: 690-1060 hPa

EN: temperature: from -25°C to +60°C

humidity: <85% pressure: 690-1060 hPa







BroLux

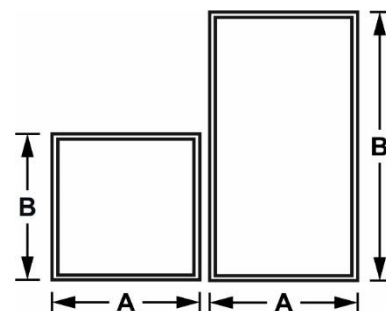









TIMAN

PANELE LED

CZ: LED panely/ SK: LED panely/ EN: LED panel



INDEX	 ABC					PF		A [mm]	B [mm]	
001515	Timan LED	40W	3200 lm	80 lm/W	4000K	>0.9	Czarny Černá Čierná Black	595	595	590221 6799479

			
AC 230V	SMD LED	120°	
		IP	
>80	40000 h	20	
			

Uwagi / Komentář / Komentáre

PL: Zasilacz w komplecie

CZ: Napájení je součástí dodávky

SK: Napájanie je súčasťou dodávky

EN: Power supply included

Materiał / Materiál / Material

PL: aluminium

CZ: hliník

SK: hliník

EN: aluminum

Optymalne warunki eksploatacji:

Optimální provozní podmínky:

Optimálne prevádzkové podmienky:

Optimal operating conditions:

PL: temperatura.: od -25°C do +60°C

wilgotność: <85% ciśnienie: 690-1060 hPa

CZ: teplota: od -25°C do +60°C

vlhkost: <85% tlak: 690-1060 hPa

SK: teplota: od -25°C do +60°C

vlhkost: <85% tlak: 690-1060 hPa

EN: temperature: from -25°C to +60°C

humidity: <85% pressure: 690-1060 hPa

DO PANELU LED TIMAN

CZ: LED panely/ SK: LED panely/ EN: LED panel







A

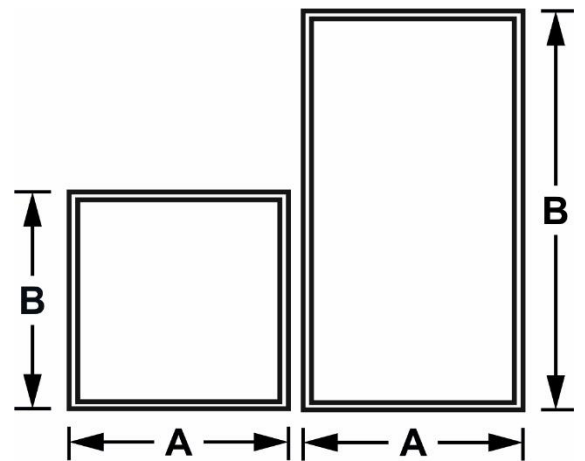

B



	INDEX		A [mm]	 B [mm]	C [mm]	
A	001003	Biały biela biela white	300	1200	50	5902216725614
A	5353		600	1200	50	5902216725621
B	001491		595	595	50	5902216723085



Materiał / Materiál / Materiál

PL: aluminium

CZ: hliník

SK: hliník





EN: aluminum

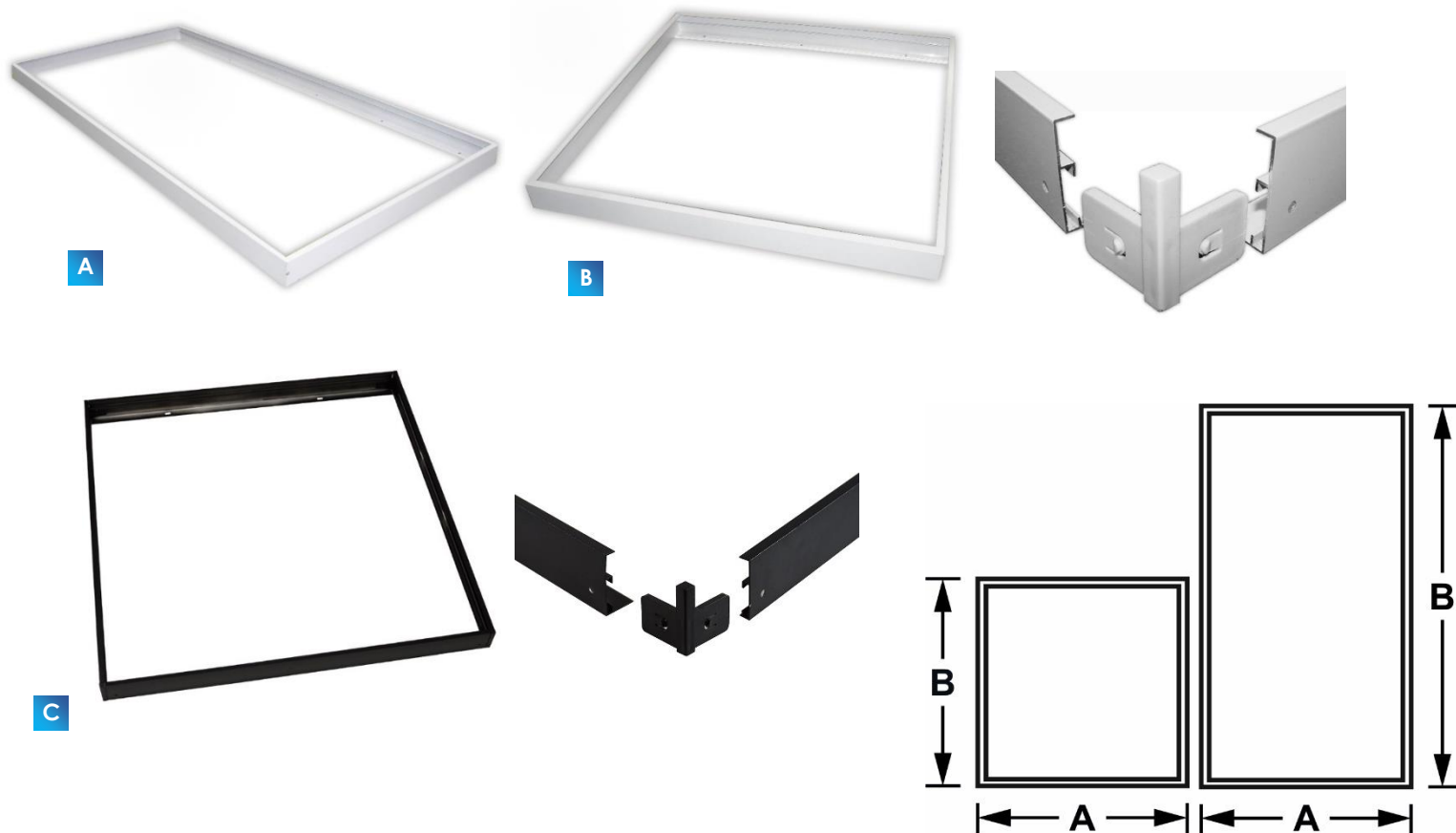

DO PANELU LED TIMAN

CZ: LED panely/ SK: LED panely/ EN: LED panel



	INDEX		A [mm]	 B [mm]	C [mm]	
A	012648	Biały bílá bielá white	300	1200	42	5902216797475
A	013286		600	1200	42	5902808800668
B	011993		600	600	42	5902216791466
C	013024	Czarny Černá Čierny Black	600	600	42	5902216799455



Materiał / Materiál / Material

PL: aluminium

CZ: hliník

SK: hliník

EN: aluminum

PANELE LED

CZ: LED panely/ SK: LED panely/ EN: LED panel

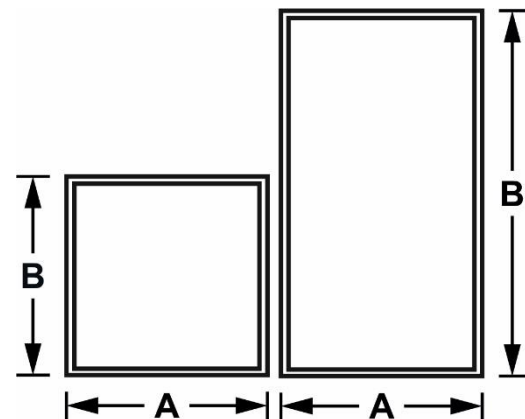

INDEX	ABC					PF		A [mm]	B [mm]		
013284	Konan LED	28W	4200 lm	150 lm/W	4000 K	0,9	Biały biela	595	595		5902808800903
013282	Konan LED	28W	4200 lm	150 lm/W	4000 K	0,9	biela white	595	595	Samsung	5902808800910

AC 230V	SMD LED	120°	
>80	40000 h	20	

Uwagi / Komentář / Komentáre

PL: Zasilacz w komplecie

CZ: Napájení je součástí dodávky

SK: Napájanie je súčasťou dodávky

EN: Power supply included

Materiał / Materiál / Material

PL: aluminium

CZ: hliník

SK: hliník

EN: aluminum

Optymalne warunki eksploatacji:

Optimální provozní podmínky:

Optimálne prevádzkové podmienky:

Optimal operating conditions:

PL: temperatura.: od -25°C do +60°C

wilgotność: <85% ciśnienie: 690-1060 hPa

CZ: teplota: od -25°C do +60°C

vlhkost: <85% tlak: 690-1060 hPa

SK: teplota: od -25°C do +60°C

vlhkost: <85% tlak: 690-1060 hPa

EN: temperature: from -25°C to +60°C

humidity: <85% pressure: 690-1060 hPa

KONAN UGR<19



PANELE LED

CZ: LED panely/ SK: LED panely/ EN: LED panel

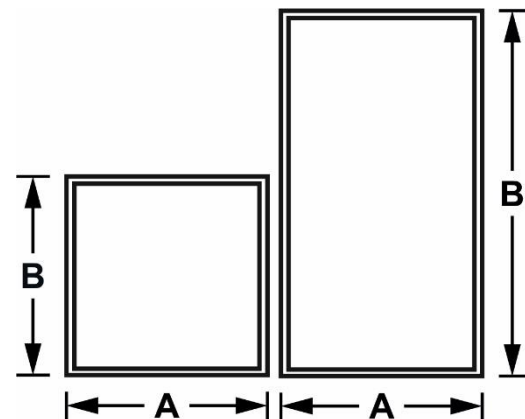

INDEX	ABC					PF		A [mm]	B [mm]		
013285	Konan LED	28W	4200 lm	150 lm/W	4000 K	0,9	Biały biła	595	595		5902808800927
013283	Konan LED	28W	4200 lm	150 lm/W	4000 K	0,9	biela white	595	595	Samsung	5902808800934

AC 230V	SMD LED	120°	
>80	40000 h	20	

Uwagi / Komentář / Komentáre

PL: Zasilacz w komplecie

CZ: Napájení je součástí dodávky

SK: Napájanie je súčasťou dodávky

EN: Power supply included

Materiał / Materiál / Material

PL: aluminium

CZ: hliník

SK: hliník

EN: aluminum

Optymalne warunki eksploatacji:

Optimální provozní podmínky:

Optimálne prevádzkové podmienky:

Optimal operating conditions:

PL: temperatura.: od -25°C do +60°C

wilgotność: <85% ciśnienie: 690-1060 hPa

CZ: teplota: od -25°C do +60°C

vlhkost: <85% tlak: 690-1060 hPa

SK: teplota: od -25°C do +60°C

vlhkost: <85% tlak: 690-1060 hPa

EN: temperature: from -25°C to +60°C

humidity: <85% pressure: 690-1060 hPa

Brolux

OPRAWY RASTER

CZ: svítidlo rastr/ SK: svietidlo raster/ EN: LED lamp raster



PHILIPS
DRIVER

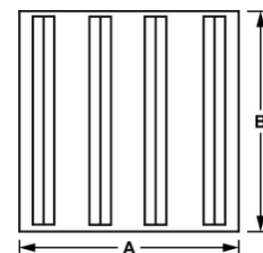

INDEX	ABC				Tc[K]		PF	A [mm]	B [mm]	
5456	MALCOLM LED	36W	4200 lm	117 lm/W	4500 K	Biały biła Bielá white	0.9	597	597	5902216785366
012301	MALCOLM LED	45W	5200 lm	116 lm/W	4000 K		0,9	597	597	5902216793736

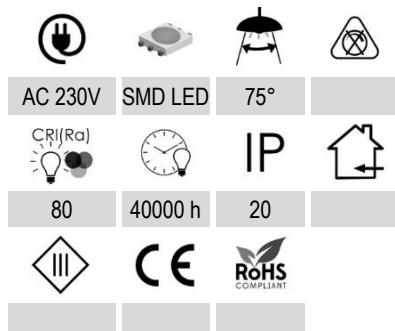

Dostępne akcesoria



012305 Klips spring panel Malcolm



012306 Linki zestaw do panelu Malcolm

Materiał / Materiál / Material

PL: blacha stalowa

CZ: kovový výlisek

SK: kovový výlisek

EN: steel plate

Optymalne warunki eksploatacji:

Optimální provozní podmínky:

Optimálne prevádzkové podmienky:

Optimal operating conditions:

PL: temperatura.: od -25°C do +60°C

wilgotność: <85% ciśnienie: 690-1060 hPa

CZ: teplota: od -25°C do +60°C

vlhkost: <85% tlak: 690-1060 hPa

SK: teplota: od -25°C do +60°C

vlhkost: <85% tlak: 690-1060 hPa

EN: temperature: from -25°C to +60°C

humidity: <85% pressure: 690-1060 hPa

Uwagi / Komentář / Komentáre

PL: Zasilacz w komplecie

CZ: Napájení je součástí dodávky

SK: Napájanie je súčasťou dodávky

EN: Power supply included



012297 Obudowa natynkowa
600x600x50mm do panelu LED Malcolm

KRIS

PANELE LED

CZ: LED panely/ SK: LED panely/ EN: LED panel

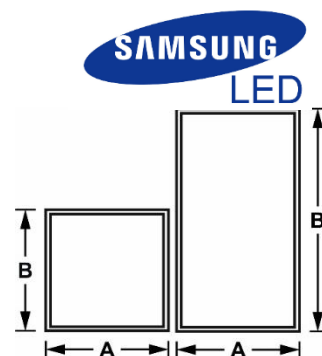

INDEX	ABC			Tc[K]	UGR	A [mm]	B [mm]	C [mm]	
045585	Kris LED	28 W	150lm/W	4000K	<19	295	1195	35	5902808809593
045493	Kris LED	28 W	150lm/W	4000K	<19	295	1195	35	5902808808947
045431	Kris LED	28 W	150lm/W	4000 K		595	595	35	5902808808664
045479	Kris LED	28 W	150lm/W	4000 K	<19	595	595	35	5902808808916
045477	Kris LED	40 W	100lm/W	3000 K		295	1195	35	5902808808961
045472	Kris LED	40 W	100lm/W	3000 K	<19	295	1195	35	5902808808954
014018	Kris LED	40 W	100lm/W	4000 K		295	1195	35	5902808808589
014019	Kris LED	40 W	100lm/W	4000 K	<19	295	1195	35	5902808808596
011996	Kris LED	40 W	150lm/W	4000 K		295	1195	35	5902808809180
045435	Kris LED	40 W	150lm/W	4000 K	<19	295	1195	35	5902808810636
011970	Kris LED	40 W	150lm/W	4000 K	<19	295	1195	35	5902808809197
014015	Kris LED	40 W	100lm/W	4000 K		595	595	35	5902808808602
014016	Kris LED	40 W	100lm/W	4000 K	<19	595	595	35	5902808808619
010488	Kris LED	40 W	150lm/W	4000 K		595	595	35	5902808805137
013901	Kris LED	40 W	150lm/W	4000 K	<19	595	595	35	5902808808640
045476	Kris LED	40 W	150lm/W	4000 K	<19	595	595	35	5902808810629
045576	Kris LED	48 W	100lm/W	4000 K		295	1195	35	5902808810612
045430	Kris LED	48 W	100lm/W	4000 K		595	595	35	5902808808657
045610	Kris LED	48 W	150lm/W	4000 K		595	1195	35	5902808809623
045611	Kris LED	48 W	150lm/W	4000 K	<19	595	1195	35	5902808809630

Biały
biłá
bielá
white

AC 230V
 SMD LED
 120
 CRI (Ra) >80
 40000 h
 IP 20
 CE
 RoHS COMPLIANT

Materiał / Materiál / Material
 PL: aluminium
 CZ: hliník
 SK: hliník
 EN: aluminum
 Optymalne warunki eksploatacji:
 Optimální provozní podmínky:
 Optimálne prevádzkové podmienky:
 Optimal operating conditions:
 PL: temperatura.: od -25°C to +60°C
 wilgotność: <85% ciśnienie: 690-1060 hPa
 CZ: teplota: od -25°C do +60°C
 vlhkost: <85% tlak: 690-1060 hPa
 SK: teplota: od -25°C do +60°C
 vlhkost: <85% tlak: 690-1060 hPa
 EN: temperature: from -25°C do +60°C
 humidity: <85% pressure: 690-1060 hPa

Uwagi / Komentář / Komentáre
 PL: Zasilacz w komplecie
 CZ: Napájení je součástí dodávky
 SK: Napájanie je súčasťou dodávky
 EN: Power supply included



KRIS RA>90

PANELE LED

CZ: LED panely/ SK: LED panely/ EN: LED panel

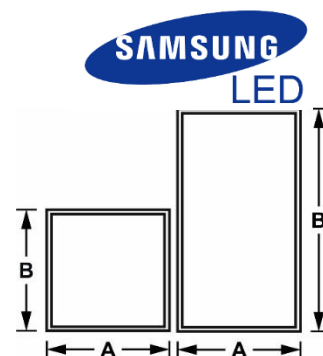

INDEX	ABC				PF	UGR		A [mm]	B [mm]	C [mm]	
045472	Kris LED	40 W	100lm/W	3000 K	0,9			295	1195	35	5902808808954
045473	Kris LED	40 W	150lm/W	3000 K	0,9			295	1195	35	5902808809951
045435	Kris LED	40 W	150lm/W	4000 K	0,9			295	1195	35	
045475	Kris LED	40 W	100 lm/W	4000 K	0,9	<19		595	595	35	5902808808978
045436	Kris LED	40 W	100lm/W	4000 K	0,9			595	595	35	
045476	Kris LED	40 W	150lm/W	4000 K	0,9	<19		595	595	35	

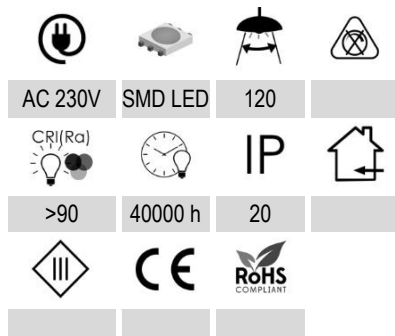

Uwagi / Komentář / Komentáre

PL: Zasilacz w komplecie

CZ: Napájení je součástí dodávky

SK: Napájanie je súčasťou dodávky

EN: Power supply included

Materiał / Materiál / Material

PL: aluminium

CZ: hliník

SK: hliník

EN: aluminum

Optymalne warunki eksploatacji:

Optimální provozní podmínky:

Optimálne prevádzkové podmienky:

Optimal operating conditions:

PL: temperatura.: od -25°C do +60°C

wilgotność: <85% ciśnienie: 690-1060 hPa

CZ: teplota: od -25°C do +60°C

vlhkost: <85% tlak: 690-1060 hPa

SK: teplota: od -25°C do +60°C

vlhkost: <85% tlak: 690-1060 hPa

EN: temperature: from -25°C do +60°C

humidity: <85% pressure: 690-1060 hPa

BroLux

KRIS DALI

PANELE LED

CZ: LED panely/ SK: LED panely/ EN: LED panel

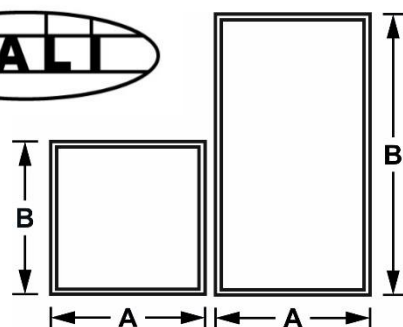

INDEX	ABC			Tc[K]	UGR	A [mm]	B [mm]	C [mm]	
045623	Kris LED	28W	150lm/W	4000K		295	1195	30	5902808809531
045624	Kris LED	28W	150lm/W	4000K	<19	295	1195	30	5902808809548
045625	Kris LED	40W	150lm/W	4000K		295	1195	30	5902808809555
045627	Kris LED	40W	100lm/W	4000K		295	1195	30	5902808809579
045628	Kris LED	40W	100lm/W	4000K	<19	295	1195	30	5902808809586
045621	Kris LED	28W	150lm/W	4000K		595	595	30	5902808809517
045622	Kris LED	28W	150lm/W	4000K	<19	595	595	30	5902808809524
045629	Kris LED	40W	100lm/W	4000K		595	595	30	5902808809470
045617	Kris LED	40W	100lm/W	4000K	<19	595	595	30	5902808809487
045618	Kris LED	40W	150lm/W	4000K		595	595	30	5902808809494
045619	Kris LED	40W	150lm/W	4000K	<19	595	595	30	5902808809500

AC 230V	SMD LED	120	DALI
CRi(Ra)	IP	20	
>80 icon"/>			
>80	40000 h	20	
III	CE	RoHS COMPLIANT	

Materiał / Materiál / Material

PL: aluminium

CZ: hliník

SK: hliník

EN: aluminum

Optymalne warunki eksploatacji:

Optimální provozní podmínky:

Optimálne prevádzkové podmienky:

Optimal operating conditions:

PL: temperatura.: od -25°C to +60°C

wilgotność: <85% ciśnienie: 690-1060 hPa

CZ: teplota: od -25°C do +60°C

vlhkost: <85% tlak: 690-1060 hPa

SK: teplota: od -25°C do +60°C

vlhkost: <85% tlak: 690-1060 hPa

EN: temperature: from -25°C do +60°C

humidity: <85% pressure: 690-1060 hPa

Uwagi / Komentář / Komentáre

PL: Zasilacz w komplecie

CZ: Napájení je součástí dodávky

SK: Napájanie je súčasťou dodávky

EN: Power supply included

Brolux

www.bowi.com.pl

DO PANELU LED KRIS

CZ: LED panely/ SK: LED panely/ EN: LED panel

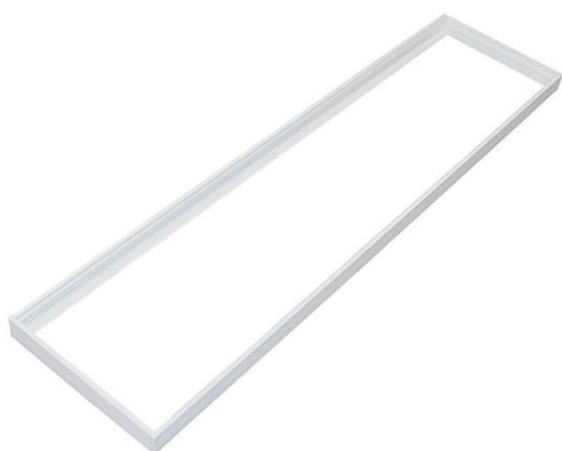





A

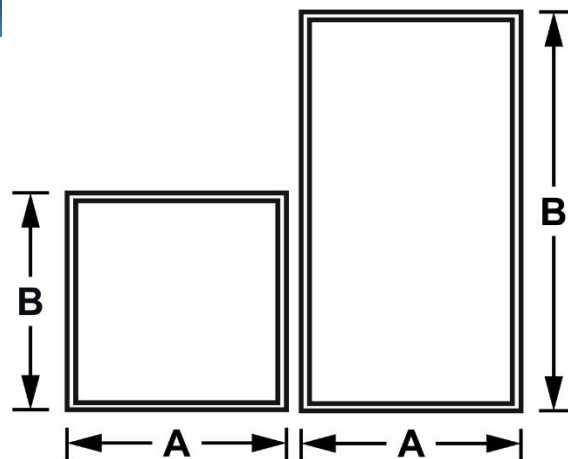
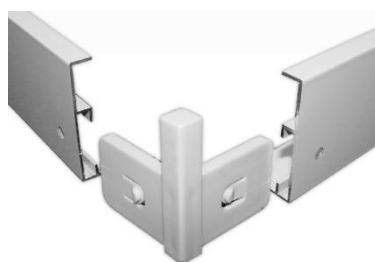

B



	INDEX		A [mm]	 B [mm]	C [mm]	
A	9513	Biały biela	300	1200	65	5902808808572
B	010485	biela white	600	600	65	5902216708198



Materiał / Materiál / Materiál

PL: aluminium

CZ: hliník

SK: hliník

EN: aluminum

CLEAN

PANELE LED

CZ: LED panely/ SK: LED panely/ EN: LED panel

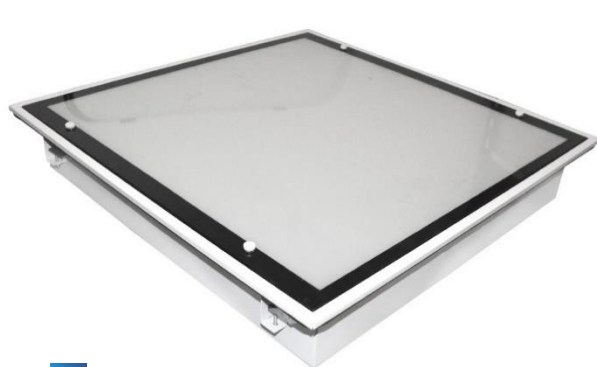

A



B



C

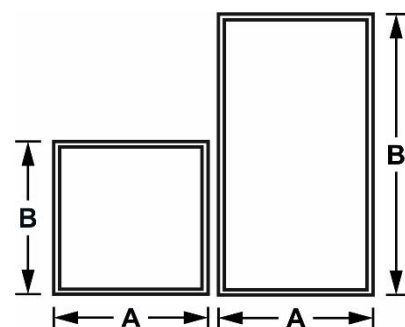

		INDEX				T_c [K]		A [mm]	B [mm]	C [mm]	
A		013908	Zeus LED	40 W	105lm/W	4000 K		595	595	100	5902808807926
B		013909	Posejdon LED	40 W	105lm/W	4000 K		595	595	100	5902808807933
C		013910	Hades LED	40 W	105lm/W	4000 K		595	595	100	5902808807940



AC 230V



SMD LED



120



>80



40000 h



IP



65



Materiał / Materiál / Material

PL: aluminium

CZ: hliník

SK: hliník

EN: aluminum

Optymalne warunki eksploatacji:

Optimální provozní podmínky:

Optimálne prevádzkové podmienky:

Optimal operating conditions:

PL: temperatura.: od -25°C to +60°C

wilgotność: <85% ciśnienie: 690-1060 hPa

CZ: teplota: od -25°C do +60°C

vlhkosť: <85% tlak: 690-1060 hPa

SK: teplota: od -25°C do +60°C

vlhkosť: <85% tlak: 690-1060 hPa

EN: temperature: from -25°C do +60°C

humidity: <85% pressure: 690-1060 hPa

Uwagi / Komentář / Komentáre

PL: Zasilacz w komplecie

CZ: Napájení je součástí dodávky

SK: Napájanie je súčasťou dodávky

EN: Power supply included

Brolux

PANELE LED

CZ: LED panely/ SK: LED panely/ EN: LED panel



A



B

	INDEX	ABC				Tc[K]	PF		A [mm]	B [mm]	C [mm]	
A	045897	Kronos LED	40W	4400 lm	110 lm/W	4000 K	0,9	Czarny Černá Čierná Black	600	600	15	5902808811251
B	045938	Kronos LED	40W	4400 lm	110 lm/W	4000 K	0,9	Biały biła bielá white	600	600	15	5902808811466



AC 230V



SMD LED



IP



20



CE



RoHS
COMPLIANT

Uwagi / Komentář / Komentáre

PL: Zasilacz w komplecie

CZ: Napájení je součástí dodávky

SK: Napájanie je súčasťou dodávky

EN: Power supply included

Materiał / Materiál / Material

PL: aluminium

CZ: hliník

SK: hliník

EN: aluminum

Optymalne warunki eksploatacji:

Optimální provozní podmínky:

Optimálne prevádzkové podmienky:

Optimal operating conditions:

PL: temperatura.: od -25°C do +60°C

wilgotność: <85% ciśnienie: 690-1060 hPa

CZ: teplota: od -25°C do +60°C

vlhkost: <85% tlak: 690-1060 hPa

SK: teplota: od -25°C do +60°C

vlhkost: <85% tlak: 690-1060 hPa

EN: temperature: from -25°C to +60°C

humidity: <85% pressure: 690-1060 hPa

TRYTON

PANELE LED

CZ: LED panely/ SK: LED panely/ EN: LED panel

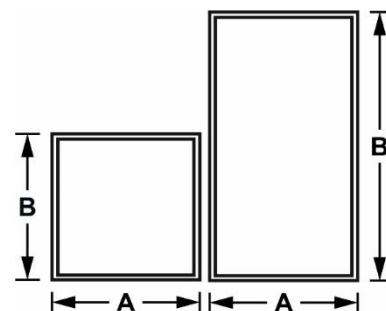

INDEX						PF		A [mm]	B [mm]	
045831	Tryton LED	40W	4800 lm	120 lm/W	4000K	>0.9		595	595	5902808811237

AC 230V	SMD LED	120°	IP
CRI(Ra)	>80	40000 h	20
RoHS COMPLIANT	CE	RoHS COMPLIANT	

Uwagi / Komentář / Komentáre

PL: Zasilacz w komplecie

CZ: Napájení je součástí dodávky

SK: Napájanie je súčasťou dodávky

EN: Power supply included

Materiał / Materiál / Material

PL: aluminium

CZ: hliník

SK: hliník

EN: aluminum

Optymalne warunki eksploatacji:

Optimální provozní podmínky:

Optimálne prevádzkové podmienky:

Optimal operating conditions:

PL: temperatura.: od -25°C do +60°C

wilgotność: <85% ciśnienie: 690-1060 hPa

CZ: teplota: od -25°C do +60°C

vlhkost: <85% tlak: 690-1060 hPa

SK: teplota: od -25°C do +60°C

vlhkost: <85% tlak: 690-1060 hPa

EN: temperature: from -25°C to +60°C

humidity: <85% pressure: 690-1060 hPa

PANELE LED

CZ: LED panely/ SK: LED panely/ EN: LED panel

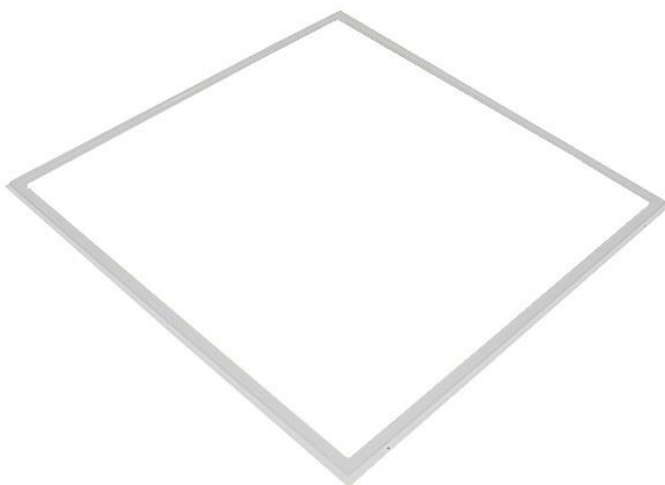

INDEX						PF		
			Lm				L X W x H	
045612	ZORDA LED	40W	4000 lm	4000 K	Bílá bilá bielá white	0.9	591x591mm	5902808809647

Materiał / Materiál / Material

PL: aluminium

CZ: hliník

SK: hliník

EN: aluminum

Uwagi / Komentář / Komentáre

PL: Zasilacz w komplecie

CZ: Napájení je součástí dodávky

SK: Napájanie je súčasťou dodávky

EN: Power supply included

AC 230V	SMD LED	103°	
80	40000 h	20	

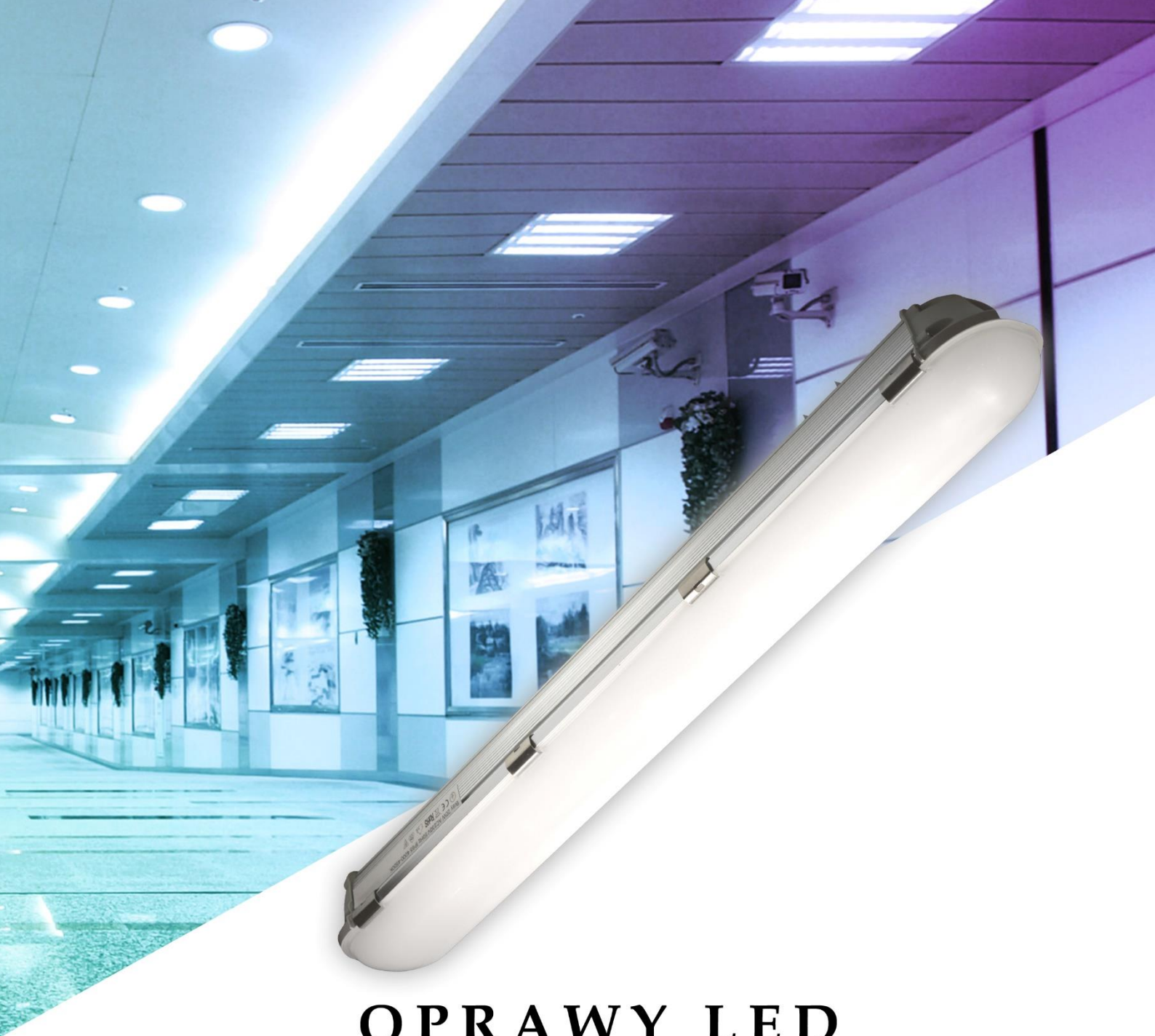

OPRAWY LED

Uniwersalny wygląd opraw liniowych LED sprawia, że nadają się do zastosowania w korytarzach, klatkach schodowych, recepcjach, biurach, warszatach, parkingach podziemnych i wszędzie tam gdzie dotąd wykorzystywano oprawy na świetlówki, które były nieefektywne i wymagały nieustannej wymiany przepalonych świetlówek. Oprawy LED mają wbudowane diody LED dzięki czemu zapewniają długą i bezawaryjną pracę przy znacznie mniejszym zużyciu mocy od tradycyjnych źródeł światła. Dzięki zastosowaniu aluminiowej obudowy oprawy są wytrzymałe na zmienne warunki eksploatacji, a stopień ochrony IP54 pozwala na użytkowanie w miejscach gdzie panuje wilgoć.

OPRAWY LED

CZ: LED svítidlo/ SK: LED svietidlo/ EN: LED lamp

SAMSUNG
LED



A

SAMSUNG
LED



B

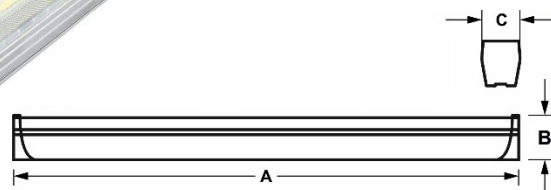

	INDEX	ABC				Tc[K]			A [mm]	B [mm]	C [mm]	
A	012512	DREY LED	40W	5200 lm	135 lm/W	4000K	Biały biła Bielá white	30°	1140	72	72	5902216795839
A	012460	DREY LED	40W	5200 lm	138 lm/W	4000K		90°	1140	72	72	5902216795754
B	012513	DREY LED	70W	9100 lm	136 lm/W	4000K		30°	1430	72	72	5902216795846
B	012160	DREY LED	70W	9100 lm	132 lm/W	4000K		90°	1430	72	72	5902216795761

		PF	
AC 230V	SMD LED	>0,9	
		IP	
>80	40000 h	20	

Dodatkowe akcesoria



012455 Linka do powieszenia oprawy Drey 2,0m zestaw 2



012456 Mocowanie oprawy Drey zestaw 2 sztuki

Materiał / Materiál / Materiál

PL: aluminium

CZ: hliník

SK: hliník

EN: aluminum

Optymalne warunki eksploatacji:

Optimální provozní podmínky:

Optimálne prevádzkové podmienky:

Optimal operating conditions:

PL: temperatura.: od -25°C do +60°C

wilgotność: <85% ciśnienie: 690-1060 hPa

CZ: teplota: od -25°C do +60°C

vlhkost: <85% tlak: 690-1060 hPa

SK: teplota: od -25°C do +60°C

vlhkost: <85% tlak: 690-1060 hPa

EN: temperature: from -25°C to +60°C

humidity: <85% pressure: 690-1060 hPa

Uwagi / Komentář / Komentáre

PL: Zasilacz w komplecie

CZ: Napájení je součástí dodávky

SK: Napájanie je súčasťou dodávky

EN: Power supply included

OPRAWY LED

CZ: LED svítidlo/ SK: LED svetidlo/ EN: LED lamp

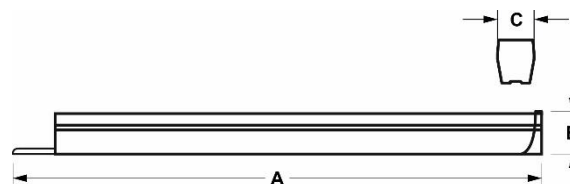

INDEX	ABC				Tc[K]			A [mm]	B [mm]	C [mm]	
012451	DREY LED	70W	9100 lm	132lm/W	4000K	Biały biła	90°	1570	72	72	5902216795778
012514	DREY LED	70W	9100 lm	136lm/W	4000K	Bielá white	30°	1570	72	72	5902216795853

		PF	
AC 230V	SMD LED	>0,9	
		IP	
>80	40000 h	20	

Dodatkowe akcesoria

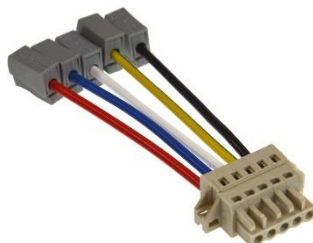

012453 Konektor zasilania AC oprawy Drey 5 przewodów



012454 Zaślepka oprawy Drey



012455 Linka do powieszenia oprawy Drey 2,0m zestaw 2



012456 Mocowanie oprawy Drey zestaw 2 sztuki



012457 Moduł zasilania oprawy Drey 5 wire

Materiał / Materiál / Material

PL: aluminium

CZ: hliník

SK: hliník

EN: aluminum

Optymalne warunki eksploatacji:

Optimální provozní podmínky:

Optimálne prevádzkové podmienky:

Optimal operating conditions:

PL: temperatura.: od -25°C o +60°C

wilgotność: <85% ciśnienie: 690-1060 hPa

CZ: teplota: od -25°C do +60°C

vlhkost: <85% tlak: 690-1060 hPa

SK: teplota: od -25°C do +60°C

vlhkost: <85% tlak: 690-1060 hPa

EN: temperature: from -25°C to +60°C

humidity: <85% pressure: 690-1060 hPa

Uwagi / Komentář / Komentáre

PL: Zasilacz w komplecie

CZ: Napájení je součástí dodávky

SK: Napájanie je súčasťou dodávky

EN: Power supply included

VOLTER PQ



OPRAWY LED

CZ: LED svítidlo/ SK: LED svietidlo/ EN: LED lamp

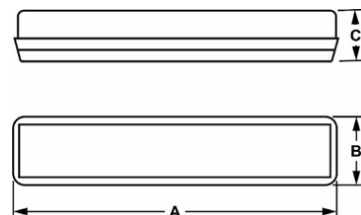

INDEX	ABC							Tc[K]		A [mm]	B [mm]	C [mm]	
045732	Volter LED	18 W	3060 lm	170 lm/W	4000 K	Szary Šedá Šedý Grey	590	85	72	5902808810902			
045698	Volter LED	30 W	5100 lm	170 lm/W	4000 K		1190	85	72	5902808810919			
045810	Volter LED	45 W	7425 lm	165 lm/W	4000 K		1190	85	72	5902808810926			
045699	Volter LED	70 W	11 200 lm	160 lm/W	4000 K		1490	85	72	5902808810933			
045924	Volter LED	30 W	5100 lm	170 lm/W	4000 K	Czarny Černá Čierny Black	1190	85	72	5902808811350			

AC 230V	SMD LED	120°	80
IP 65	IK 09	PF 0.9	RoHS COMPLIANT

Uwagi / Komentář / Komentáre

PL: Zasilacz w komplecie

CZ: Napájení je součástí dodávky

SK: Napájanie je súčasťou dodávky

EN: Power supply included

Materiał / Materiál / Material

PL: Tworzywo sztuczne PC

CZ: PC Plast

SK: PC Plast

EN: PC Plastic

Optymalne warunki eksploatacji:

Optimální provozní podmínky:

Optimálne prevádzkové podmienky:

Optimal operating conditions:

PL: temperatura.: od -25°C do +60°C

wilgotność: <85% ciśnienie: 690-1060 hPa

CZ: teplota: od -25 ° C do + 60 ° C

vlhkost: <85% tlak: 690-1060 hPa

SK: teplota: od -25 ° C do + 60 ° C

vlhkost: <85% tlak: 690-1060 hPa

EN: temperature: from -25 ° C to + 60 ° C

humidity: <85% pressure: 690-1060 hPa

BroLux

www.bowi.com.pl

VOLTER Czujnik światła



OPRAWY LED

CZ: LED svítidlo/ SK: LED svetidlo/ EN: LED lamp

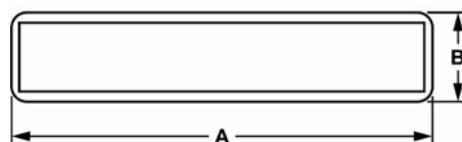
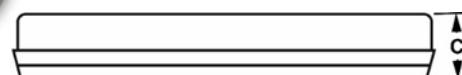

INDEX	ABC				Tc[K]		A [mm]	B [mm]	C [mm]	
046050	Volter LED	30W	5100 lm	170 lm/W	4000K	Szary Šedá Šedý Grey	1190	85	72	5902808812302

AC 230V	SMD LED	120°	80
40000 h	65	0.9	09

Materiał / Materiál / Material

PL: Tworzywo sztuczne PC

CZ: PC Plast

SK: PC Plast

EN: PC Plastic

Optymalne warunki eksploatacji:

Optimální provozní podmínky:

Optimálne prevádzkové podmienky:

Optimal operating conditions:

PL: temperatura.: od -25°C do +60°C

wilgotność: <85% ciśnienie: 690-1060 hPa

CZ: teplota: od -25°C do +60°C

vlhkosť: <85% tlak: 690-1060 hPa

SK: teplota: od -25°C do +60°C

vlhkosť: <85% tlak: 690-1060 hPa

EN: temperature: from -25°C to +60°C

humidity: <85% pressure: 690-1060 hPa

Uwagi / Komentář / Komentáre

PL: Zasilacz w komplecie

CZ: Napájení je součástí dodávky

SK: Napájanie je súčasťou dodávky

EN: Power supply included

Brulux

VOLTER Czujnik ruchu



OPRAWY LED

CZ: LED svítidlo/ SK: LED svetidlo/ EN: LED lamp

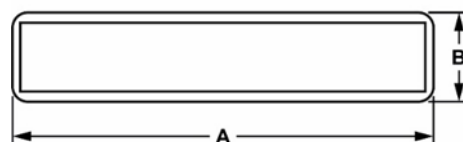
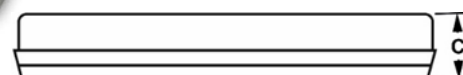

INDEX	ABC				Tc(K)		A [mm]	B [mm]	C [mm]	
046049	Volter LED	30W	5100 lm	170 lm/W	4000K	Szary Šedá Šedý Grey	1190	85	72	5902808812296

				80
AC 230V	SMD LED	120°		
	IP	PF	IK	
40000 h	65	0.9	09	PIR
		CE		

Materiał / Materiál / Material

PL: Tworzywo sztuczne PC

CZ: PC Plast

SK: PC Plast

EN: PC Plastic

Optymalne warunki eksploatacji:

Optimální provozní podmínky:

Optimálne prevádzkové podmienky:

Optimal operating conditions:

PL: temperatura.: od -25°C do +60°C

wilgotność: <85% ciśnienie: 690-1060 hPa

CZ: teplota: od -25°C do +60°C

vlhkosť: <85% tlak: 690-1060 hPa

SK: teplota: od -25°C do +60°C

vlhkosť: <85% tlak: 690-1060 hPa

EN: temperature: from -25°C to +60°C

humidity: <85% pressure: 690-1060 hPa

Uwagi / Komentář / Komentáre

PL: Zasilacz w komplecie

CZ: Napájení je součástí dodávky

SK: Napájanie je súčasťou dodávky

EN: Power supply included

Brulux

SIRMIUM



OPRAWY LED

CZ: LED svítidlo/ SK: LED svietidlo/ EN: LED lamp

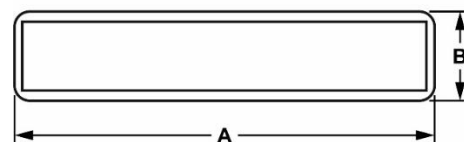
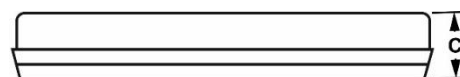

INDEX	ABC				Tc[K]		A [mm]	B [mm]	C [mm]	
013618	SIRMIUM LED	17 W	2827 lm	165 lm/W	4000 k	Szary Šedá Šedá Grey	600	75	70	5902808804048
8003	SIRMIUM LED	40 W	4092 lm	102 lm/W	4500 K		1200	75	70	5902216743502
013599	SIRMIUM LED	40 W	6600 lm	165 lm/W	4000 K		1200	75	70	5902808803973
013600	SIRMIUM LED	52 W	8580 lm	165 lm/W	4000 K		1200	75	70	5902808803980
013629	SIRMIUM LED	60 W	9600 lm	160 lm/W	4000 K		1500	75	70	5902808804284

AC 230V	SMD LED	120°		80
40000 h	65	0,9	10	

Materiał / Materiál / Material

PL: Tworzywo sztuczne PC+ABS

CZ: PC+ABS Plast

SK: PC+ABS Plast

EN: PC+ABS Plastic

Optymalne warunki eksploatacji:

Optimální provozní podmínky:

Optimálne prevádzkové podmienky:

Optimal operating conditions:

PL: temperatura.: od -25°C do +60°C

wilgotność: <85% ciśnienie: 690-1060 hPa

CZ: teplota: od -25°C do +60°C

vlhkost: <85% tlak: 690-1060 hPa

SK: teplota: od -25°C do +60°C

vlhkost: <85% tlak: 690-1060 hPa

EN: temperature: from -25°C to +60°C

humidity: <85% pressure: 690-1060 hPa

Uwagi / Komentář / Komentáre

PL: Zasilacz w komplecie

CZ: Napájení je součástí dodávky

SK: Napájanie je súčasťou dodávky

EN: Power supply included

BroLux

OPRAWY LED

CZ: LED svítidlo/ SK: LED svietidlo/ EN: LED lamp

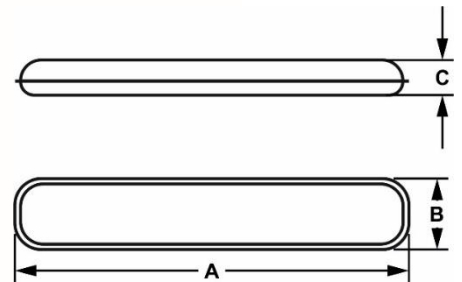

INDEX	ABC				Tc[K]			A [mm]	B [mm]	C [mm]	
6636	Bray LED	20W	1700 lm	85 lm/W	4500K		-	600	90	70	5902216714182
5789	Bray LED	40W	3400 lm	85 lm/W	4500K	Srebrny Stieborná stříbrná silver	-	1200	90	70	5902216709041
6569	Bray LED	40W	3400 lm	85 lm/W	3000K		-	1200	90	70	5902216709058
008249	Bray LED	60W	5000 lm	83 lm/W	4500K		-	1500	90	70	5902216709065
338	Bray LED	78W	11 700 lm	150 lm/W	4000K		-	1500	90	70	5902216771000
5285	Bray LED	20W	1700 lm	85 lm/W	4500K		Microwave	600	90	70	5902216714199

AC 230V	SMD LED	160°	
>80	40000 h	65	
0,95			

Uwagi / Komentář / Komentáre

PL: Zasilacz w komplecie

CZ: Napájení je součástí dodávky

SK: Napájanie je súčasťou dodávky

EN: Power supply included

Materiał / Materiál / Material

PL: aluminium

CZ: hliník

SK: hliník

EN: aluminum

Optymalne warunki eksploatacji:

Optimální provozní podmínky:

Optimálne prevádzkové podmienky:

Optimal operating conditions:

PL: temperatura.: od -25°C do +60°C

wilgotność: <85% ciśnienie: 690-1060 hPa

CZ: teplota: od -25°C do +60°C

vlhkost: <85% tlak: 690-1060 hPa

SK: teplota: od -25°C do +60°C

vlhkost: <85% tlak: 690-1060 hPa

EN: temperature: from -25°C to +60°C

humidity: <85% pressure: 690-1060 hPa

OPRAWY LED

CZ: LED svítidlo/ SK: LED svietidlo/ EN: LED lamp

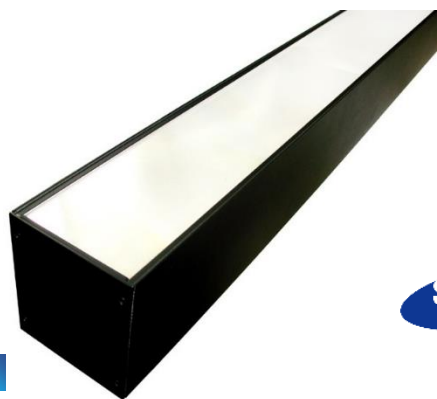

A



B

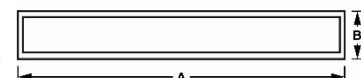
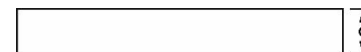

	INDEX	ABC				Tc[K]		A [mm]	B [mm]	C [mm]	
A	013548	Cabail LED	24 W	2391 lm	100 lm/W	4000 K	Czarny Černá Čierny Black	600	50	72,5	5902808804000
	013550	Cabail LED	40 W	4400 lm	110 lm/W	3000 K		1200	50	72,5	5902808807360
A	013015	Cabail LED	40 W	4400 lm	110 lm/W	4000 K		1200	50	72,5	5902808801115
B	013330	Cabail LED	40 W	4400 lm	110 lm/W	4000 K	Biały biła Bielá white	1200	50	72,5	5902808801122
A	013016	Cabail LED	50 W	5500 lm	110 lm/W	4000 K	Czarny Černá Čierny Black	1500	50	72,5	5902808801092

AC 230V	SMD LED	80°	≥80
40000 h	IP	PF	UGR
20	0,9	21	
CE	RoHS COMPLIANT		



013564 Podsufitka oprawy liniowej Cabail okrągła biała op/2szt. Długość linki: 1 m



013565 Podsufitka oprawy liniowej Cabail okrągła czarna op/2szt. Długość linki: 1 m



013632. Podsufitka oprawy liniowej Cabail prostokątna czarna op/2szt. Długość linki 1 m

Materiał / Materiál / Materiál

PL: aluminium

CZ: hliník

SK: hliník

EN: aluminum

Optymalne warunki eksploatacji:

Optimální provozní podmínky:

Optimálne prevádzkové podmienky:

Optimal operating conditions:

PL: temperatura.: od -25°C do +60°C

wilgotność: <85% ciśnienie: 690-1060 hPa

CZ: teplota: od -25°C do +60°C

vlhkost: <85% tlak: 690-1060 hPa

SK: teplota: od -25°C do +60°C

vlhkosť: <85% tlak: 690-1060 hPa

EN: temperature: from -25°C to +60°C

humidity: <85% pressure: 690-1060 hPa

Uwagi / Komentář / Komentáre

PL: Zasilacz w komplecie

CZ: Napájení je součástí dodávky

SK: Napájanie je súčasťou dodávky

EN: Power supply included

CABAIL KINKET



OPRAWY LED

CZ: LED svítidlo/ SK: LED svietidlo/ EN: LED lamp



SAMSUNG
LED

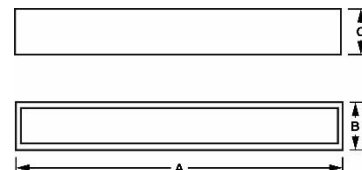

INDEX	ABC				Tc[K]		A [mm]	B [mm]	C [mm]	
013874	Cabail LED	24 W	2400 lm	100 lm/W	4000 K	Czarny	600	65	79	5902808807414
013873	Cabail LED	40 W	4000 lm	100 lm/W	4000 K	Černá Čierny Black	1200	65	79	5902808807421

AC 230V	SMD LED	70°	IP	PF
≥80	40000 h	20	0,9	

Materiał / Materiál / Material

PL: aluminium

CZ: hliník

SK: hliník

EN: aluminum

Optymalne warunki eksploatacji:

Optimální provozní podmínky:

Optimálne prevádzkové podmienky:

Optimal operating conditions:

PL: temperatura.: od -25°C do +60°C

wilgotność: <85% ciśnienie: 690-1060 hPa

CZ: teplota: od -25°C do +60°C

vlhkost: <85% tlak: 690-1060 hPa

SK: teplota: od -25°C do +60°C

vlhkost: <85% tlak: 690-1060 hPa

EN: temperature: from -25°C to +60°C

humidity: <85% pressure: 690-1060 hPa

Uwagi / Komentář / Komentáre

PL: Zasilacz w komplecie

CZ: Napájení je součástí dodávky

SK: Napájanie je súčasťou dodávky

EN: Power supply included

BroLux

www.bowi.com.pl

CABAIL ŁĄCZONA



OPRAWY LED

CZ: LED svítidlo/ SK: LED svetidlo/ EN: LED lamp

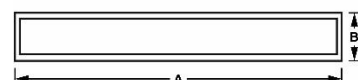

INDEX	ABC				Tc[K]		A [mm]	B [mm]	C [mm]	
013336	Cabail LED	40 W	4400 lm	110 lm/W	4000 K	Czarny Černá Čierny Black	1200	50	72,5	5902808801108

AC 230V	SMD LED	70°	IP	PF
≥80	40000 h	20	0,9	

Materiał / Materiál / Material

PL: aluminium

CZ: hliník

SK: hliník

EN: aluminum

Optymalne warunki eksploatacji:

Optimální provozní podmínky:

Optimálne prevádzkové podmienky:

Optimal operating conditions:

PL: temperatura.: od -25°C do +60°C

wilgotność: <85% ciśnienie: 690-1060 hPa

CZ: teplota: od -25°C do +60°C

vlhkost: <85% tlak: 690-1060 hPa

SK: teplota: od -25°C do +60°C

vlhkost: <85% tlak: 690-1060 hPa

EN: temperature: from -25°C to +60°C

humidity: <85% pressure: 690-1060 hPa

Uwagi / Komentář / Komentáre

PL: Zasilacz w komplecie

CZ: Napájení je součástí dodávky

SK: Napájanie je súčasťou dodávky

EN: Power supply included

Brölux

www.bowi.com.pl

CABAIL ŁĄCZONY DALI

OPRAWY LED

CZ: LED svítidlo/ SK: LED svetidlo/ EN: LED lamp









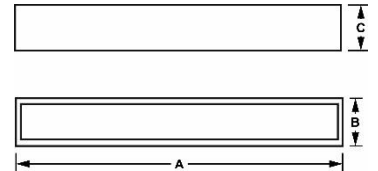

A

SAMSUNG
LED



B



	 INDEX			 Lm	 Lm	 Tc[K]		A [mm]	B [mm]	C [mm]	
A	045615	Cabail LED	40 W	4000 lm	100 lm/W	4000 K	Czarny Černá Čierny Black	1200	50	72,5	5902808809463
B	045614	Cabail LED	40 W	4000 lm	100 lm/W	4000 K	Biały biła bielá white	1200	50	72,5	5902808809456

Dostępne Akcesoria:











013337 Łącznik prosty



013338 Łącznik kątowy czarny



013350 Łącznik kątowy biały

			
	IP	PF	
40000 h	20		≥80
		CE	

Materiał / Material / Material

PL: aluminium

CZ: hliník

SK: hliník

EN: aluminum

Optymalne warunki eksploatacji:

Optimální provozní podmínky:

Optimálne prevádzkové podmienky:

Optimal operating conditions:

PL: temperatura.: od -25°C do +60°C

wilgotność: <85% ciśnienie: 690-1060 hPa

CZ: teplota: od -25°C do +60°C

vlhkost: <85% tlak: 690-1060 hPa

SK: teplota: od -25°C do +60°C

vlhkost: <85% tlak: 690-1060 hPa

EN: temperature: from -25°C to +60°C

humidity: <85% pressure: 690-1060 hPa

Uwagi / Komentář / Komentáre

PL: Zasilacz w komplecie

CZ: Napájení je součástí dodávky

SK: Napájanie je súčasťou dodávky

EN: Power supply included

OPRAWY LED

CZ: LED svítidlo/ SK: LED svietidlo/ EN: LED lamp



	INDEX	ABC							A [mm]	B [mm]	C [mm]	
A	046022	Cabail LED	18 W	2520 lm	140 lm/W	4000 k	PIR	Czarny Černá Čierna Black	600	50	72,5	5902808812470
	045990	Cabail LED	24W	2400 lm	100lm/W	4000 K			600	50	72,5	5902808812210
	013937	Cabail LED	40 W	4400 lm	110 lm/W	4000 K			1200	50	72,5	5902808807995
B	008302	Cabail LED	40 W	4400 lm	110 lm/W	4000 K	Mikrofalowy		1200	50	72,5	5902808807537

AC 230V	SMD LED	80°	≥80
40000 h	20	0,9	<21

Dostępne akcesoria



013564 Podsufitka oprawy liniowej Cabail okrągła biała



013565 Podsufitka oprawy liniowej Cabail okrągła czarna

Optymalne warunki eksploatacji:

Optimální provozní podmínky:
Optimálne prevádzkové podmienky:
Optimal operating conditions:
PL: temperatura.: od -25°C do +60°C
wilgotność: <85% ciśnienie: 690-1060 hPa
CZ: teplota: od -25°C do +60°C
vlhkost: <85% tlak: 690-1060 hPa
SK: teplota: od -25°C do +60°C
vlhkost: <85% tlak: 690-1060 hPa
EN: temperature: from -25°C to +60°C
humidity: <85% pressure: 690-1060 hPa

Uwagi / Komentář / Komentáre

PL: Zasilacz w komplecie

CZ: Napájení je součástí dodávky

SK: Napájanie je súčasťou dodávky

EN: Power supply included

Materiał / Materiál / Materiál

PL: aluminium

CZ: hliník

SK: hliník

EN: aluminum

OPRAWY LED

CZ: LED svítidlo/ SK: LED svietidlo/ EN: LED lamp



A

B

SAMSUNG
LED

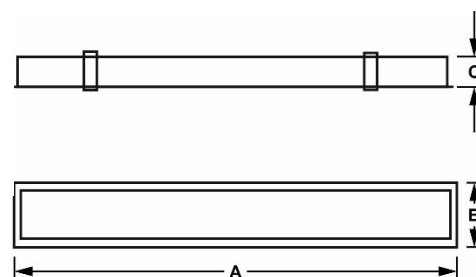

	INDEX			Lm	Lm	Tc[K]		PF				
A	013720	Edom LED	24 W	2640 lm	110lm/W	4000K	Biały Bílá Bielá White	0,9	600	90	70	5902808805922
A	009201	Edom LED	36 W	2800 lm	78 lm/W	4000K		0,9	1200	90	70	5902216793132
A	013718	Edom LED	40 W	4400 lm	110 lm/W	4000K		0,9	1200	90	70	5902808805946
B	013721	Edom LED	24 W	2640 lm	110 lm/W	4000K	Czarny Černá Čierny Black	0,9	600	90	70	5902808805939
B	009214	Edom LED	36 W	2800 lm	78 lm/W	4000K		0,9	1200	90	70	5902216793149
B	013719	Edom LED	40 W	4400 lm	110 lm/W	4000K		0,9	1200	90	70	5902808805953

AC 230V	SMD LED	120°	IP	UGR
80	40000 h	20	21	

Uwagi / Komentář / Komentáre

PL: Zasilacz w komplecie

CZ: Napájení je součástí dodávky

SK: Napájanie je súčasťou dodávky

EN: Power supply included

Materiał / Materiál / Material

PL: aluminium

CZ: hliník

SK: hliník

EN: aluminum

Optymalne warunki eksploatacji:

Optimální provozní podmínky:

Optimálne prevádzkové podmienky:

Optimal operating conditions:

PL: temperatura.: od -25°C do +60°C

wilgotność: <85% ciśnienie: 690-1060 hPa

CZ: teplota: od -25°C do +60°C

vlhkost: <85% tlak: 690-1060 hPa

SK: teplota: od -25°C do +60°C

vlhkost: <85% tlak: 690-1060 hPa

EN: temperature: from -25°C to +60°C

humidity: <85% pressure: 690-1060 hPa

EDOM DALI



OPRAWY LED

CZ: LED svítidlo/ SK: LED svietidlo/ EN: LED lamp



A



B

SAMSUNG
LED

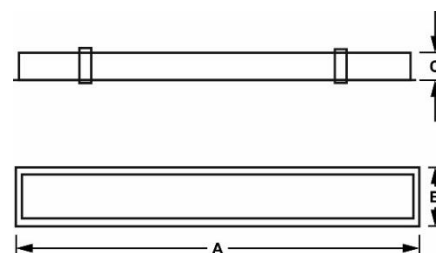

	INDEX			Lm	Lm	Tc[K]		PF				
A	004736	Edom LED	24 W	1872 lm	78 lm/W	4000K	Bílý Bílá White	0.9	600	90	70	5902216716940
A	000509	Edom LED	40 W	3120 lm	78 lm/W	4000K	Bílý Bílá White	0.9	1200	90	70	5902216720954
B	006050	Edom LED	24 W	1872 lm	78 lm/W	4000K	Czarny Černá Čierny Black	0.9	600	90	70	5902216788701
B	008458	Edom LED	40 W	3120 lm	78 lm/W	4000K	Czarny Černá Čierny Black	0.9	1200	90	70	5902216720947

AC 230V	SMD LED	120°	DALI
CRi(Ra)	40000 h	IP 20	UGR 21

Uwagi / Komentář / Komentáre

PL: Zasilacz w komplecie

CZ: Napájení je součástí dodávky

SK: Napájanie je súčasťou dodávky

EN: Power supply included

Materiał / Materiál / Material

PL: aluminium

CZ: hliník

SK: hliník

EN: aluminum

Optymalne warunki eksploatacji:

Optimální provozní podmínky:

Optimálne prevádzkové podmienky:

Optimal operating conditions:

PL: temperatura.: od -25°C do +60°C

wilgotność: <85% ciśnienie: 690-1060 hPa

CZ: teplota: od -25°C do +60°C

vlhkost: <85% tlak: 690-1060 hPa

SK: teplota: od -25°C do +60°C

vlhkost: <85% tlak: 690-1060 hPa

EN: temperature: from -25°C to +60°C

humidity: <85% pressure: 690-1060 hPa

Brulux

OPRAWY LED

CZ: LED svítidlo/ SK: LED svietidlo/ EN: LED lamp

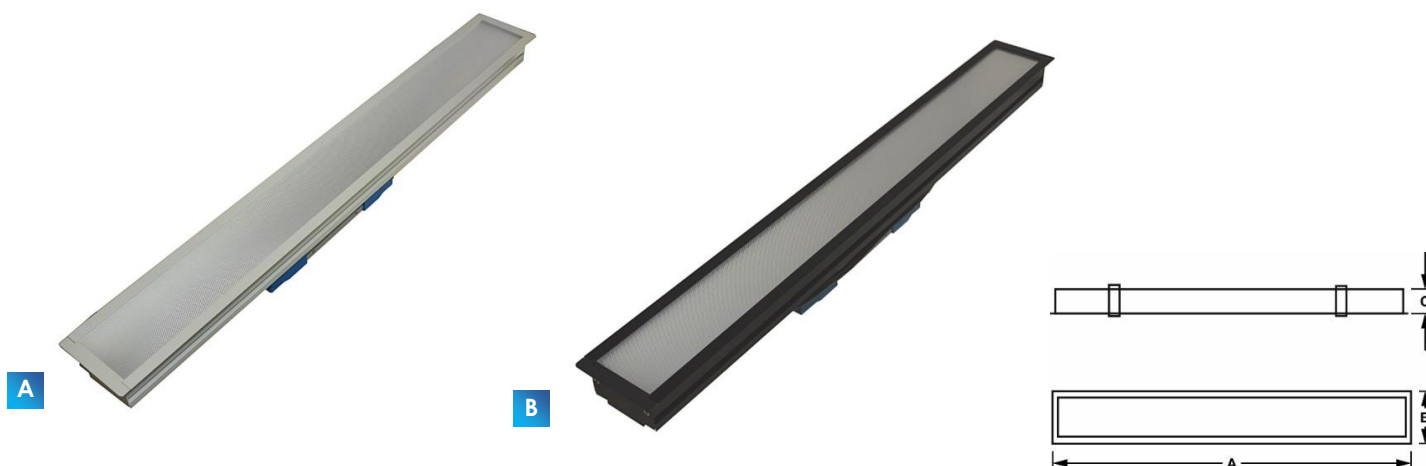

	INDEX	ABC		Lm	Tc(K)		PF				
A	045929	Redom LED	24W	2160 lm	4000K	Biały Bílá Bielá White	0,9	600	48	30	5902808811381
A	045931	Redom LED	42W	3780 lm	4000K		0.9	1200	48	30	5902808811411
B	045928	Redom LED	24W	2160 lm	4000K	Czarny Černá Čierny Black	0,9	600	48	30	5902808811398
B	045930	Redom LED	42W	3780 lm	3000K		0.9	1200	48	30	5902808811404
B	045932	Redom LED	42W	3780 lm	4000K		0,9	1200	48	30	5902808811428

AC 230V	SMD LED	109°	
80	20		

Uwagi / Komentář / Komentáre

PL: Zasilacz w komplecie

CZ: Napájení je součástí dodávky

SK: Napájanie je súčasťou dodávky

EN: Power supply included

Materiał / Materiál / Material

PL: aluminium

CZ: hliník

SK: hliník

EN: aluminum

Optymalne warunki eksploatacji:

Optimální provozní podmínky:

Optimálne prevádzkové podmienky:

Optimal operating conditions:

PL: temperatura.: od -25°C do +60°C

wilgotność: <85% ciśnienie: 690-1060 hPa

CZ: teplota: od -25°C do +60°C

vlhkost: <85% tlak: 690-1060 hPa

SK: teplota: od -25°C do +60°C

vlhkost: <85% tlak: 690-1060 hPa

EN: temperature: from -25°C to +60°C

humidity: <85% pressure: 690-1060 hPa

OPRAWY LED

CZ: LED svítidlo/ SK: LED svietidlo/ EN: LED lamp

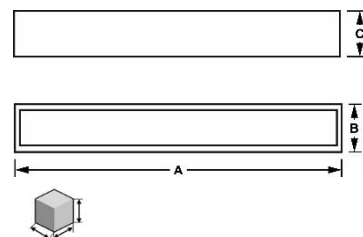

	INDEX	ABC				Tc[K]		PF	A [mm]	B [mm]	C [mm]	
A	013048	Alia LED	40W	6000lm	150 lm/W	4000K		0.9	1180	32	70	5902808804574
B	013620	Alia LED	60W	9000 lm	150 lm/W	4000K	Czarny Černá Čierna Black	0.9	1480	32	70	5902808804581

AC 230V	SMD LED	90°	IP
80	40000 h	40	RoHS COMPLIANT

Uwagi / Komentář / Komentáre

PL: Zasilacz w komplecie

CZ: Napájení je součástí dodávky

SK: Napájanie je súčasťou dodávky

EN: Power supply included

Materiał / Materiál / Material

PL: aluminium

CZ: hliník

SK: hliník

EN: aluminum

Optymalne warunki eksploatacji:

Optimální provozní podmínky:

Optimálne prevádzkové podmienky:

Optimal operating conditions:

PL: temperatura.: od -25°C do +60°C

wilgotność: <85% ciśnienie: 690-1060 hPa

CZ: teplota: od -25°C do +60°C

vlhkost: <85% tlak: 690-1060 hPa

SK: teplota: -25°C do +60°C

vlhkost: <85% tlak: 690-1060 hPa

EN: temperature: from -25°C to +60°C

humidity: <85% pressure: 690-1060 hPa

LUNO

OPRAWY LED

CZ: LED svítidlo/ SK: LED svietidlo/ EN: LED lamp



A

B

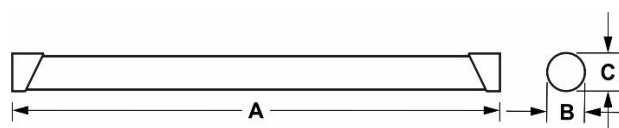

	INDEX	ABC				Tc[K]		A [mm]	B [mm]	C [mm]	
A	007126	Luno LED	36W	3400 lm	94 lm/W	4000K	Srebrny Srebrná stříbrná Silver	1175	74	74	5902216793491
B	012347	Luno LED	36W	3400 lm	94 lm/W	4000K	Czarny Černá Čierna Black	1175	74	74	5902216794375

AC 230V	SMD LED	270°	
>80	40000 h	20	
0.9			

Uwagi / Komentář / Komentáre

PL: Zasilacz w komplecie

CZ: Napájení je součástí dodávky

SK: Napájanie je súčasťou dodávky

EN: Power supply included

Materiał / Materiál / Material

PL: aluminium

CZ: hliník

SK: hliník

EN: aluminum

Optymalne warunki eksploatacji:

Optimální provozní podmínky:

Optimálne prevádzkové podmienky:

Optimal operating conditions:

PL: temperatura.: od -25°C do +60°C

wilgotność: <85% ciśnienie: 690-1060 hPa

CZ: teplota: od -25°C do +60°C

vlhkost: <85% tlak: 690-1060 hPa

SK: teplota: od -25°C do +60°C

vlhkosť: <85% tlak: 690-1060 hPa

EN: temperature: from -25°C to +60°C

humidity: <85% pressure: 690-1060 hPa

BroLux

OPRAWY LED

CZ: LED svítidlo/ SK: LED svietidlo/ EN: LED lamp

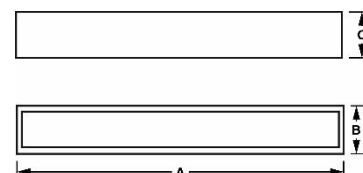

INDEX	ABC						A [mm]	B [mm]	C [mm]	
014009	Ronse LED	36 W	111 lm/W	3956 lm	4000 K	Biały biłá	1200	36	47	5902808808558
012088	Ronse LED	50 W	115l m/W	5591 lm	4000 K	Bielá white	1500	36	47	5902808808565

AC 230V	SMD LED	120°	IP	PF
≥80	40000 h	65	CE	ROHS COMPLIANT

Materiał / Materiál / Material

PL: PC
CZ: PC
SK: PC
EN: PC

Optymalne warunki eksploatacji: Optimální provozní podmínky: Optimálne prevádzkové podmienky: Optimal operating conditions:

PL: temperatura.: od -25°C do +60°C
wilgotność: <85% ciśnienie: 690-1060 hPa
CZ: teplota: od -25°C do +60°C
vlhkost: <85% tlak: 690-1060 hPa
SK: teplota: od -25°C do +60°C
vlhkost: <85% tlak: 690-1060 hPa
EN: temperature: from -25°C to +60°C
humidity: <85% pressure: 690-1060 hPa

Uwagi / Komentář / Komentáre

PL: Zasilacz w komplecie
CZ: Napájení je součástí dodávky
SK: Napájanie je súčasťou dodávky
EN: Power supply included

FADIA

OPRAWY LED

CZ: LED svítidlo/ SK: LED svietidlo/ EN: LED lamp

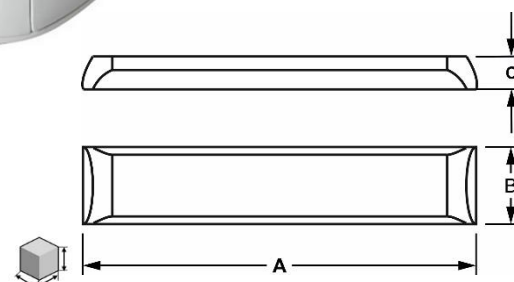

INDEX	ABC						A [mm]	B [mm]	C [mm]	
004565	Fadia	16 W	1400 lm	88 lm/W	4000 K	Biały	600	135	46	5902216770874
012300	Fadia	32 W	2800 lm	88 lm/W	6500 K	biała	1200	135	46	5902216793668
004566	Fadia	32 W	2800 lm	88 lm/W	4000 K	Bielá white	1200	135	46	5902216793675

AC 230V	SMD LED	115°	IP	PF
80	40000 h	44/20	0,9	

Uwagi / Komentář / Komentáre

PL: Zasilacz w komplecie

CZ: Napájení je součástí dodávky

SK: Napájanie je súčasťou dodávky

EN: Power supply included

Materiał / Materiál / Material

PL: tworzywo sztuczne PC, metal

CZ: PC plast, kov

SK: PC plast, kov

EN: PC plastic, metal

Optymalne warunki eksploatacji:

Optimální provozní podmínky:

Optimálne prevádzkové podmienky:

Optimal operating conditions:

PL: temperatura.: od -25°C do +60°C

wilgotność: <85% ciśnienie: 690-1060 hPa

CZ: teplota: od -25°C do +60°C

vlhkost: <85% tlak: 690-1060 hPa

SK: teplota: od -25°C do +60°C

vlhkost: <85% tlak: 690-1060 hPa

EN: temperature: from -25°C to +60°C

humidity: <85% pressure: 690-1060 hPa

BroLux

FELAN

OPRAWY LED

CZ: LED svítidlo/ SK: LED svetidlo/ EN: LED lamp

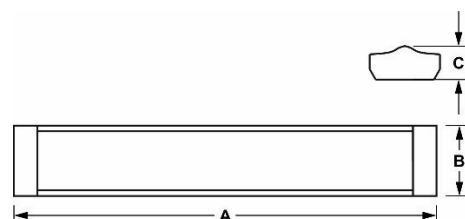

INDEX	ABC				Tc[K]		A [mm]	B [mm]	C [mm]	
012605	FELAN	20 W	2000 lm	100 lm/W	4000 K		644	185	76	5902216796812
012606	FELAN	40 W	4000 lm	100 lm/W	4000 K		1254	185	76	5902216796829
012607	FELAN	60 W	6000 lm	100 lm/W	4000 K		1554	185	76	5902216796836

AC 230V	SMD LED	120°	IP	PF
80	40000 h	20	0,9	

Materiał / Materiál / Material

PL: tworzywo sztuczne PC, aluminium

CZ: PC plast, hliník

SK: PC plast, hliník

EN: PC plastic, aluminum

Optymalne warunki eksploatacji:

Optimální provozní podmínky:

Optimálne prevádzkové podmienky:

Optimal operating conditions:

PL: temperatura.: od -25°C do +60°C

wilgotność: <85% ciśnienie: 690-1060 hPa

CZ: teplota: od -25°C do +60°C

vlhkost: <85% tlak: 690-1060 hPa

SK: teplota: od -25°C do +60°C

vlhkost: <85% tlak: 690-1060 hPa

EN: temperature: from -25°C to +60°C

humidity: <85% pressure: 690-1060 hPa

Uwagi / Komentář / Komentáre

PL: Zasilacz w komplecie

CZ: Napájení je součástí dodávky

SK: Napájanie je súčasťou dodávky

EN: Power supply included



OGIMA

OPRAWY LED

CZ: LED svítidlo/ SK: LED svietidlo/ EN: LED lamp

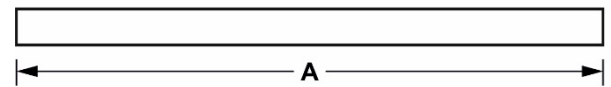
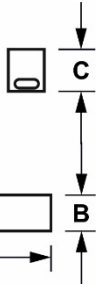

INDEX	ABC						A [mm]	B [mm]	C [mm]	
012665	OGIMA	30 W	3300 lm	110 lm/W	4000 K	Biały biła Bielá white	1151	36	40	5902216796812
012858	OGIMA	30 W	3300 lm	110 lm/W	4000 K		1151	36	40	5902216796829
012826	OGIMA	40 W	4400 lm	110 lm/W	4000 K		1485	36	40	5902216796836

Dodatkowe akcesoria



012859 Zestaw linek do powieszenia



AC 230V

SMD LED

120°



IP

PF

80

40000 h

20

0,9



Materiał / Materiál / Material

PL: tworzywo sztuczne PC, aluminium

CZ: PC plast, hliník

SK: PC plast, hliník

EN: PC plastic, aluminum

Optymalne warunki eksploatacji:

Optimální provozní podmínky:

Optimálne prevádzkové podmienky:

Optimal operating conditions:

PL: temperatura.: od -25°C do +60°C

wilgotność: <85% ciśnienie: 690-1060 hPa

CZ: teplota: od -25°C do +60°C

vlhkost: <85% tlak: 690-1060 hPa

SK: teplota: od -25°C do +60°C

vlhkost: <85% tlak: 690-1060 hPa

EN: temperature: from -25°C to +60°C

humidity: <85% pressure: 690-1060 hPa

Uwagi / Komentář / Komentáre

PL: Zasilacz w komplecie

CZ: Napájení je součástí dodávky

SK: Napájanie je súčasťou dodávky

EN: Power supply included

BroLux

www.bowi.com.pl

HANAN

OPRAWY LED

CZ: LED svítidlo/ SK: LED svetidlo/ EN: LED lamp



SAMSUNG
LED

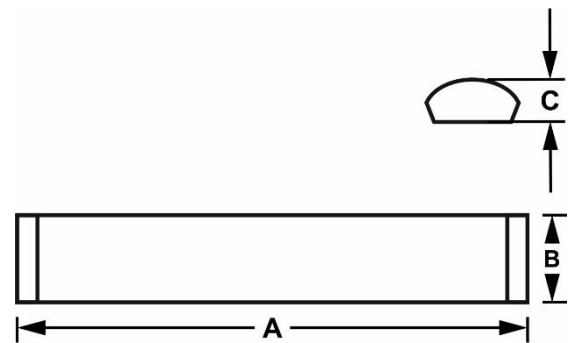

INDEX	ABC			Tc[K]		A [mm]	B [mm]	C [mm]
012685	HANAN	39 W	3900 lm	4000 K	Biały biela biely white	1225	198	68
012650	HANAN	49 W	4900 lm	4000 K		1490	198	68

				UGR
AC 230V	SMD LED	120°		<19
>90	40000 h	20	0,95	

Materiał / Material / Material

PL: tworzywo sztuczne PC, aluminium

CZ: PC plast, hliník

SK: PC plast, hliník

EN: PC plastic, aluminium

Uwagi / Komentář / Komentáre

PL: Zasilacz w komplecie

CZ: Napájení je součástí dodávky

SK: Napájanie je súčasťou dodávky

EN: Power supply included

BroLux

www.bowi.com.pl

VILER

OPRAWY LED

CZ: LED svítidlo/ SK: LED svietidlo/ EN: LED lamp



INDEX	ABC			Tc[K]		A [mm]	B [mm]	C [mm]	
013662	VILER	21 W	150 lm/W	4000 K	Biały bílá Bielá white	600	84	72	5902808804390

AC 230V	SMD LED	120°	
CRi(Ra)	40000 h	65	0,95

Materiał / Materiál / Material

PL: tworzywo sztuczne PC, aluminium

CZ: PC plast, hliník

SK: PC plast, hliník

EN: PC plastic, aluminum

Uwagi / Komentář / Komentáre

PL: Zasilacz w komplecie

CZ: Napájení je součástí dodávky

SK: Napájanie je súčasťou dodávky

EN: Power supply included

Brolux

ERGON

OPRAWY LED

CZ: LED svítidlo/ SK: LED svietidlo/ EN: LED lamp



INDEX	ABC					A [mm]	B [mm]	C [mm]	
013662	ERGON	40 W	127 lm/W	4000 K	Srebrny Stieborný stříbrná Silver	1230	90	100	5902808806707

AC 230V	SMD LED	150°	
CRI(Ra)	40000 h	IP	PF
>80	40000 h	65	0,9

Materiał / Materiál / Material

PL: szkło, aluminium

CZ: sklo, hliník

SK: sklo, hliník

EN: glass, aluminum

Uwagi / Komentář / Komentáře

PL: Zasilacz w komplecie

CZ: Napájení je součástí dodávky

SK: Napájanie je súčasťou dodávky

EN: Power supply included

Brolux

EDULF

OPRAWY LED

CZ: LED svítidlo/ SK: LED svietidlo/ EN: LED lamp



Diody i zasilacz

OSRAM

INDEX	ABC					A [mm]	B [mm]	C [mm]	
008404	EDULF	50 W	72 lm/W	4000 K	Biały biła Bielá white	1245	40	90	5902808804390

AC 230V	SMD LED	20°	
CRi/Ra		IP	PF
>80	40000 h	20	0,9

Materiał / Materiál / Materiál

PL: tworzywo sztuczne PC, aluminium

CZ: PC plast, hliník

SK: PC plast, hliník

EN: PC plastic, aluminum

Uwagi / Komentář / Komentáre

PL: Zasilacz w komplecie

CZ: Napájení je součástí dodávky

SK: Napájanie je súčasťou dodávky



EN: Power supply included

Bro**l**ux

OPRAWY DO ŚWIETŁÓWEK LED

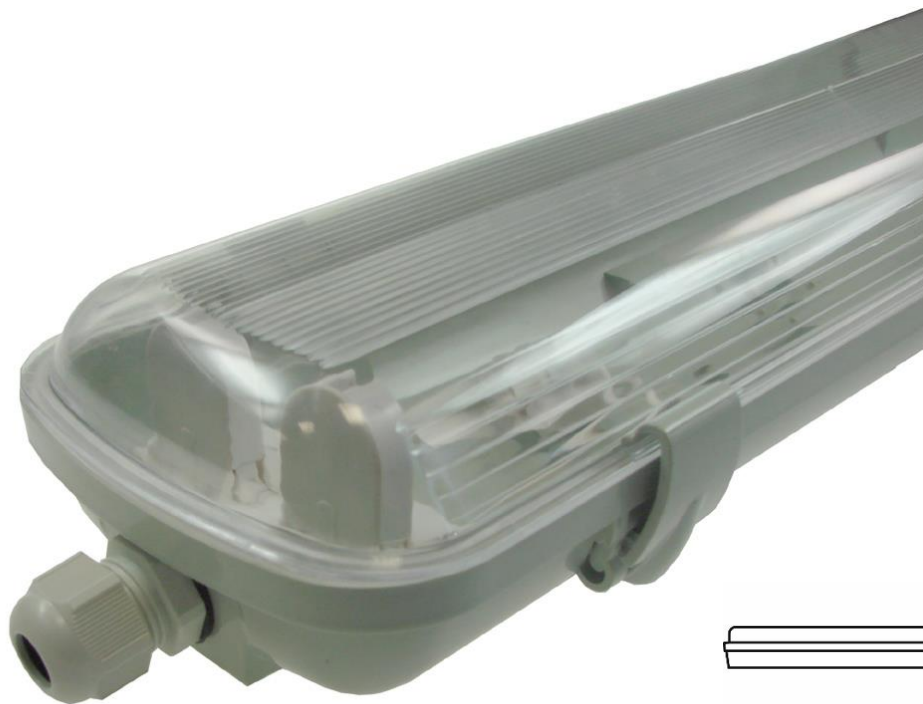
CZ: LED svítidlo/ SK: LED svietidlo/ EN: LED lamp



INDEX		Możliwa do zainstalowania długość świetlówki LED	A [mm]	B [mm]	C [mm]	
013644	Szary Šedá Šedý Grey	120 cm	1260	84	72	5902808804291

IP 

65

CE

RoHS
COMPLIANT

Materiał / Materiál / Material

PL: Tworzywo sztuczne ABS+PS

CZ: ABS+PS Plast

SK: ABS+PS Plast

EN: ABS+PS Plastic



BRENTLY



TRACK LIGHT

CZ: Lištové svítidlo COB LED / SK: Lištové svetidlo COB LED / EN: track light

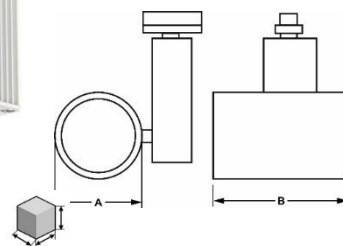

CITIZEN

LED

A	INDEX	ABC	Icon: Plug	Icon: Light	Icon: Light	Icon: Light	Icon: Light	Icon: Light	Rodzaj szyny zasilania	A [mm]	B [mm]	Barcode
A	012074	Brently	30W	2800 lm	93 lm/W	4000 K	Czarny	18°	1-fazowa	94	134	5902216791282
A	012075	Brently	30W	2800 lm	93 lm/W	3000 K	Čierná Black	18°	1-fazowa	94	134	5902216791299
B	012076	Brently	30W	2800 lm	93lm/W	3000 K	Biały	18°	1-fazowa	94	134	5902216791312
B	012077	Brently	30W	2800 lm	93lm/W	4000 K	Bielá white	18°	1-fazowa	94	134	5902216791329
A	012081	Brently	30W	2800 lm	93lm/W	3000 K	Czarny	18°	3-fazowa	94	134	5902216791336
A	012082	Brently	30W	2800 lm	93lm/W	4000 K	Čierná Black	18°	3-fazowa	94	134	5902216791343
B	012515	Brently	30W	2800 lm	93lm/W	3000 K	Biały	18°	3-fazowa	94	134	5902808800804
B	013163	Brently	30W	2800 lm	93lm/W	4000 K	Bielá white	18°	3-fazowa	94	134	5902808800811

Icon: Plug	Icon: COB	Icon: Recycle	Icon: House
AC 230V	COB		
Icon: CRI/Ra	Icon: Clock	IP	UGR
>90	40000 h	20	23
PF	Icon: Ground	CE	RoHS COMPLIANT
0,95			

Uwagi / Komentář / Komentáre

PL: Zasilacz w komplecie

CZ: Napájení je součástí dodávky

SK: Napájanie je súčasťou dodávky

EN: Power supply included

Materiał / Materiál / Material

PL: aluminium

CZ: hliník

SK: hliník

EN: aluminum

Optymalne warunki eksploatacji:

Optimální provozní podmínky:

Optimálne prevádzkové podmienky:

Optimal operating conditions:

PL: temperatura: od -25°C do +60°C

wilgotność: <85% ciśnienie: 690-1060 hPa

CZ: teplota: od -25°C do +60°C

vlhkosť: <85% tlak: 690-1060 hPa

SK: teplota: od -25°C do +60°C

vlhkosť: <85% tlak: 690-1060 hPa

EN: temperature: from -25°C to +60°C

humidity: <85% pressure: 690-1060 hPa

Brulux

BRENTLY DALI



TRACK LIGHT

CZ: Lištové svítidlo COB LED / SK: Lištové svietidlo COB LED / EN: track light



A



B

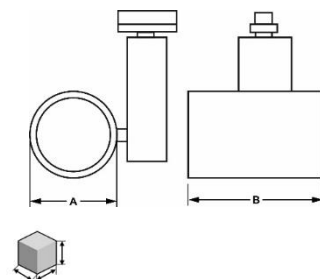

	INDEX			Lm	Lm	Tc[K]			Rodzaj szyny zasilania	A [mm]	B [mm]	
A	045593	Brently	30W	2800 lm	93 lm/W	3000 K	Czarny Černá Čierny Black	18°	1-fazowa	94	134	5902808809449
B	045594	Brently	30W	2800 lm	93lm/W	4000 K	Biały biła biela white	18°	1-fazowa	94	134	5902808809432

AC 230V	COB		
		IP	UGR
>90	40000 h	20	23
PF		CE	
0,95			

Uwagi / Komentář / Komentáre

PL: Zasilacz w komplecie

CZ: Napájení je součástí dodávky

SK: Napájanie je súčasťou dodávky

EN: Power supply included

Materiał / Materiál / Material

PL: aluminium

CZ: hliník

SK: hliník

EN: aluminum

Optymalne warunki eksploatacji:

Optimální provozní podmínky:

Optimálne prevádzkové podmienky:

Optimal operating conditions:

PL: temperatura.: od -25°C do +60°C

wilgotność: <85% ciśnienie: 690-1060 hPa

CZ: teplota: od -25°C do +60°C

vlhkost: <85% tlak: 690-1060 hPa

SK: teplota: od -25°C do +60°C

vlhkosť: <85% tlak: 690-1060 hPa

EN: temperature: from -25°C to +60°C

humidity: <85% pressure: 690-1060 hPa

Br^olux

TRACK LIGHT

CZ: Lištové svítidlo COB LED / SK: Lištové svetidlo COB LED / EN: track light

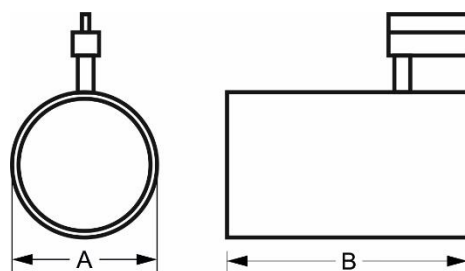
CITIZEN
LED

INDEX	ABC				Tc[K]			Rodzaj szyny zasilania	A [mm]	B [mm]	
012950	Brasco	40W	3200lm	80lm/W	3000 K	Biały biła Bielá white	24	3-fazowa	100	180	5902216798991



AC 230V

COB

IP

PF



IP

PF

>90

40000 h

20

0,95



Materiał / Materiál / Material

PL: aluminium

CZ: hliník

SK: hliník

EN: aluminum

Optymalne warunki eksploatacji:

Optimální provozní podmínky:

Optimálne prevádzkové podmienky:

Optimal operating conditions:

PL: temperatura.: od -10°C do +25°C

wilgotność: <85% ciśnienie: 690-1060 hPa

CZ: teplota: od -10 ° C do + 25 ° C

vlhkost: <85% tlak: 690-1060 hPa

SK: teplota: od -10 ° C do + 25 ° C

vlhkost: <85% tlak: 690-1060 hPa

EN: temperature: from -10 ° C to + 25 ° C

humidity: <85% pressure: 690-1060 hPa

Uwagi / Komentář / Komentáre

PL: Zasilacz w komplecie

CZ: Napájení je součástí dodávky

SK: Napájanie je súčasťou dodávky

EN: Power supply included

TRACK LIGHT

CZ: Lištové svítidlo COB LED / SK: Lištové svetidlo COB LED / EN: track light



A



B

CITIZEN
LED

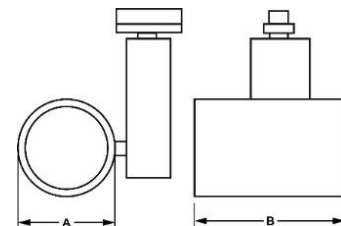

	INDEX	ABC				Tc[K]			Rodzaj szyny zasilania	A [mm]	B [mm]	
A	013628	TRYCO	40W	2597 lm	65lm/W	3000 K	Czarny	24°	1-fazowa			5902808804260
A	013627	TRYCO	40W	2597 lm	65lm/W	3000 K	Černá Black	24°	3-fazowa			5902808804277
B	012951	TRYCO	40W	3200 lm	80lm/W	3000 K	Biały Bielá white	24°	3-fazowa	100	135	5902216799004

AC 230V	COB		
		IP	PF
>90	40000 h	20	0,95

Uwagi / Komentář / Komentáre

PL: Zasilacz w komplecie

CZ: Napájení je součástí dodávky

SK: Napájanie je súčasťou dodávky

EN: Power supply included

Materiał / Materiál / Material

PL: aluminium

CZ: hliník

SK: hliník

EN: aluminum

Optymalne warunki eksploatacji:

Optimální provozní podmínky:

Optimálne prevádzkové podmienky:

Optimal operating conditions:

PL: temperatura.: od -10°C do +25°C

wilgotność: <85% ciśnienie: 690-1060 hPa

CZ: teplota: od -10 ° C do + 25 ° C

vlhkost: <85% tlak: 690-1060 hPa

SK: teplota: od -10 ° C do + 25 ° C

vlhkost: <85% tlak: 690-1060 hPa

EN: temperature: from -10 ° C to + 25 ° C

humidity: <85% pressure: 690-1060 hPa

TRACK LIGHT

CZ: Lištové svítidlo COB LED / SK: Lištové svetidlo COB LED / EN: track light



INDEX	ABC				Tc[K]			Rodzaj szyny zasilania	A [mm]	B [mm]	
013757	Robis	40W	lm	lm/W	2700 K	Biała biła Bielá white	24	3-fazowa			5902808805595

AC 230V	COB	IP	PF
>90	40000 h	20	0,95

Uwagi / Komentář / Komentáre

PL: Zasilacz w komplecie

CZ: Napájení je součástí dodávky

SK: Napájanie je súčasťou dodávky

EN: Power supply is included

Materiał / Materiál / Material

PL: aluminium

CZ: hliník

SK: hliník

EN: aluminum

Optymalne warunki eksploatacji:

Optimální provozní podmínky:

Optimálne prevádzkové podmienky:

Optimal operating conditions:

PL: temperatura.: od -10°C do +25°C

wilgotność: <85% ciśnienie: 690-1060 hPa

CZ: teplota: od -10 ° C do + 25 ° C

vlhkost: <85% tlak: 690-1060 hPa

SK: teplota: od -10 ° C do + 25 ° C

vlhkosť: <85% tlak: 690-1060 hPa

EN: temperature: from -10 ° C to + 25 ° C

humidity: <85% pressure: 690-1060 hPa

MORBIS



TRACK LIGHT

CZ: Lištové svítidlo COB LED / SK: Lištové svetidlo COB LED / EN: track light



CITIZEN LED

INDEX	ABC				Tc[K]			Rodzaj szyny zasilania	A [mm]	B [mm]	
013758	Morbis	30W	lm	lm/W	6000 K	Biały biła Bielá white	24	3-fazowa			5902808805601

AC 230V	COB		
CRI(Ra)	40000 h	IP	PF
>90		20	0,95

Uwagi / Komentář / Komentáre

PL: Zasilacz w komplecie

CZ: Napájení je součástí dodávky

SK: Napájanie je súčasťou dodávky

EN: Power supply is included

Materiał / Materiál / Material

PL: aluminium

CZ: hliník

SK: hliník

EN: aluminum

Optymalne warunki eksploatacji:

Optimální provozní podmínky:

Optimálne prevádzkové podmienky:

Optimal operating conditions:

PL: temperatura.: od -10°C do +25°C

wilgotność: <85% ciśnienie: 690-1060 hPa

CZ: teplota: od -10 ° C do + 25 ° C

vlhkosť: <85% tlak: 690-1060 hPa

SK: teplota: od -10 ° C do + 25 ° C

vlhkosť: <85% tlak: 690-1060 hPa

EN: temperature: from -10 ° C to + 25 ° C

humidity: <85% pressure: 690-1060 hPa

KARBIS



TRACK LIGHT

CZ: Lištové svítidlo COB LED / SK: Lištové svetidlo COB LED / EN: track light



CITIZEN
LED



INDEX	ABC				Tc[K]			Rodzaj szyny zasilania	A [mm]	B [mm]	
013759	Karbis	40W	lm	lm/W	4000 K	Biała biła Bielá white	24	3-fazowa			5902808805618

AC 230V	COB		
CRI(Ra)	40000 h	IP	PF
>90		20	0,95

Uwagi / Komentář / Komentáre

PL: Zasilacz w komplecie

CZ: Napájení je součástí dodávky

SK: Napájanie je súčasťou dodávky

EN: Power supply is included

Materiał / Materiál / Material

PL: aluminium

CZ: hliník

SK: hliník

EN: aluminum

Optymalne warunki eksploatacji:

Optimální provozní podmínky:

Optimálne prevádzkové podmienky:

Optimal operating conditions:

PL: temperatura.: od -10°C do +25°C

wilgotność: <85% ciśnienie: 690-1060 hPa

CZ: teplota: od -10 ° C do + 25 ° C

vlhkost: <85% tlak: 690-1060 hPa

SK: teplota: od -10 ° C do + 25 ° C

vlhkost: <85% tlak: 690-1060 hPa

EN: temperature: from -10 ° C to + 25 ° C

humidity: <85% pressure: 690-1060 hPa

TRACK LIGHT

CZ: Lištové svítidlo COB LED / SK: Lištové svietidlo COB LED / EN: track light



INDEX	ABC							Rodzaj szyny zasilania	A [mm]	B [mm]	
010418	ORHAM	30W	3000 lm	100 lm/W	2700 K		18°		80	200	5902216789074
004701	ORHAM	30W	3000 lm	100 lm/W	4000 K	Czarny Černá Čierná Black	18°	1-fazowa	80	200	5902808807827
003387	ORHAM	30W	3000 lm	100 lm/W	4000K		40°		80	200	5902808807810

AC 230V	COB	IP	PF
>80	40000 h	20	>0,5

Uwagi / Komentář / Komentáre

PL: Zasilacz w komplecie

CZ: Napájení je součástí dodávky

SK: Napájanie je súčasťou dodávky

EN: Power supply included

Materiał / Materiál / Material

PL: aluminium

CZ: hliník

SK: hliník

EN: aluminum

Optymalne warunki eksploatacji:

Optimální provozní podmínky:

Optimálne prevádzkové podmienky:

Optimal operating conditions:

PL: temperatura.: od -10°C do +25°C

wilgotność: <85% ciśnienie: 690-1060 hPa

CZ: teplota: od -10 ° C do + 25 ° C

vlhkost: <85% tlak: 690-1060 hPa

SK: teplota: od -10 ° C do + 25 ° C

vlhkost: <85% tlak: 690-1060 hPa

EN: temperature: from -10 ° C to + 25 ° C

humidity: <85% pressure: 690-1060 hPa

NATYNKOWY



SYSTEM SZYNOPRZEWODOWY 3-FAZOWY

CZ: Kolejnicové lineární vedení / Lištový spoj / SK: Kol'ajnicové lineárne vedenia / EN: track rail



	INDEX			L	Wymiar poprzeczny [mm]	
A	010666	Adar	Biały biłá Bielá white	1 m	36,4 × 32,2mm	5902216715622
A	009238	Adar		1,5 m	36,4 × 32,2mm	5902216715639
A	010672	Adar		2 m	36,4 × 32,2mm	5902216701939
B	009237	Adar	Srebrny Stieborná stříbrná silver	1 m	36,4 × 32,2mm	5902216746237
B	010671	Adar		1,5 m	36,4 × 32,2mm	5902216744585
B	010673	Adar		2 m	36,4 × 32,2mm	5902216715646
C	2031	Pant	Czarny Černá Čierná Black	1 m	36,4 × 32,2mm	5902216708983
C	2048	Pant		2 m	36,4 × 32,2mm	5902216708990
C	012058	Adar		2 m	36,4 × 32,2mm	5902216791244
D	001366	Gildas	Biały biłá Bielá white	2 m	42 × 32,2 mm	5902216708952
E	012057	Gildas	Czarny Černá Čierná Black	2 m	42 × 32,2 mm	5902216791237



Materiał / Materiál / Material

PL: aluminium

CZ: hliník

SK: hliník

EN: aluminum

BroLux

NATYNKOWY



SYSTEM SZYNOPRZEWODOWY 1-FAZOWY

CZ: Kolejnicové lineární vedení / Lištový spoj / SK: Kol'ajnicové lineárne vedenia / EN: track rail







A



B



C

	INDEX				Wymiar poprzeczny [mm]	
A	010692	Pant	Biały bílá Bielá white	1 m	21 × 34mm	5902216701908
A	010696	Pant		1,5 m	21 × 34mm	5902216701922
A	010697	Pant		2 m	21 × 34mm	5902216701915
C	003456	Pant	Czarny Černá Čierná Black	1 m	21 × 34mm	5902216708969
C	003906	Pant		2 m	21 × 34mm	5902216708976
B	010694	Pant	Srebrny Stieborná stříbrná silver	1 m	21 × 34mm	5902216715615
B	010695	Pant		1,5 m	21 × 34mm	5902216758841
B	010698	Pant		2 m	21 × 34mm	5902216746220



Materiał / Materiál / Material

PL: aluminium

CZ: hliník

SK: hliník

EN: aluminum

BroLux

PODTYNKOWY



SYSTEM SZYNOPRZEWODOWY 1-FAZOWY

CZ: Kolejnicové lineární vedení / Lištový spoj / SK: Kol'ajnicové lineárne vedenia / EN: track rail



A



B

	INDEX	ABC		L	Wymiar poprzeczny [mm]	
A	011854	Pant	Biały biłá Bielá white	2 m	50x19,5mm	5902216787827
B	011855	Pant	Czarny Černá Čierná Black	2 m	50x19,5mm	5902216787834



Materiał / Materiál / Materiál

PL: aluminium

CZ: hliník

SK: hliník

EN: aluminum

Br**o**lux

AKCESORIA



AKCESORIA SZYNY 1-FAZOWEJ

CZ: 1-fázové železniční příslušenství / SK: 1-fázové železničné príslušenstvo / EN: 1-phase rail accessories



INDEX



A	010705	Pant	Biały bílá Bielá white	5902216748545
B	010701	Pant		5902216748613
C	010699	Pant		5902216701878
D	010703	Pant		5902216789111
E	010707	Pant		5902216774513
F	011836	Pant		5902216792067
G	010709	Pant	5902216752733	Srebrny Srieborná stříbrná silver
H	011838	Pant	5902216787841	
I	010706	Pant	5902216748552	
J	010702	Pant	5902216748620	
K	010700	Pant	5902216721869	
L	010704	Pant	5902216748606	
M	010708	Pant	5902216725836	Czarny Černá Čierná Black
N	010710	Pant	5902216752726	
O	012146	Pant	5902216792074	
P	012145	Pant	5902216792050	
R	004932	Pant	5902216715592	
S	011839	Pant	5902216787810	
T	011837	Pant	5902216787858	5902216787865
U	011856	Pant	5902216787865	
V	004579	Pant	5902216748590	

Materiał / Materiál / Material

PL: aluminium

CZ: hliník

SK: hliník

EN: aluminum



BroLux

www.bowi.com.pl

AKCESORIA



AKCESORIA SZYNY 3-FAZOWEJ

CZ: 3-fázové přípojnice přípojníc / SK: 3-fázové príslušenstvo prípojníc / EN: 3-phase rail accessories

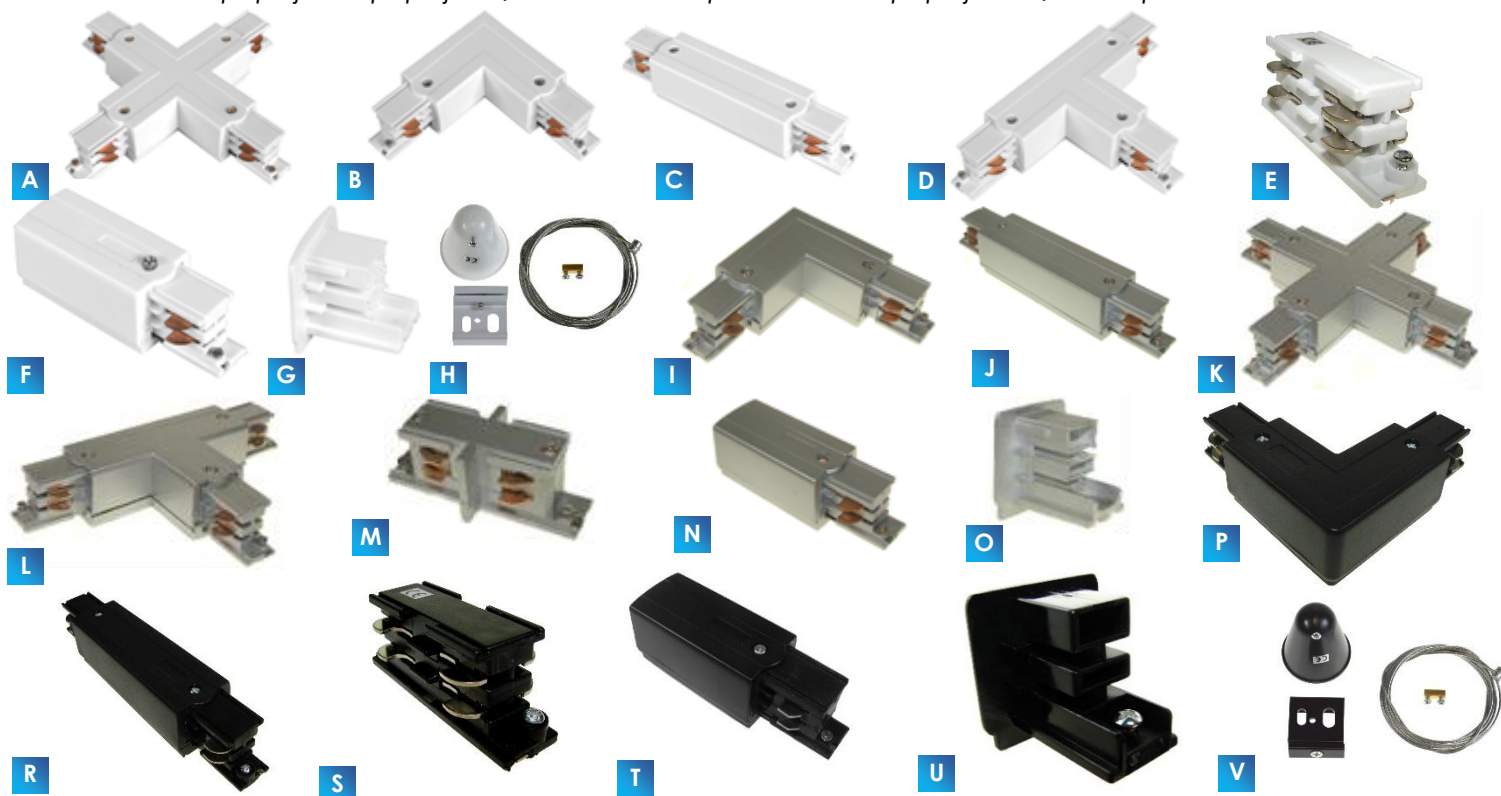

INDEX



A	010681	Adar	Biały biła Bielá white	5902216748576
B	010678	Adar		5902216715608
C	010674	Adar		5902216721883
D	010679	Adar		5902216721906
E	010687	Adar		5902216701885
F	010683	Adar		5902216748637
G	010690	Adar		5902216752719
H	012501	Adar		5902216795792
I	010684	Adar		5902216748569
J	010677	Adar		5902216721876
K	010675	Adar	Srebrny Stieborná stříbrná silver	5902216721890
L	010680	Adar		5902216748538
M	010688	Adar		5902216701892
N	010685	Adar		5902216748644
O	010691	Adar		5902216752702
P	012143	Adar		5902216792036
R	012142	Adar		5902216792029
S	012141	Adar		5902216792012
T	004580	Adar		5902216774506
U	012140	Adar		5902216792005
V	012502	Adar	Czarny Černá Čierná Black	5902216795808



Materiał / Materiál / Materiál

PL: aluminium

CZ: hliník

SK: hliník

EN: aluminum



PROFIL BASIC



PROFIL NAROŻNY SREBRNY

CZ: rohový profil / SK: rohový profil / EN: corner profile



A

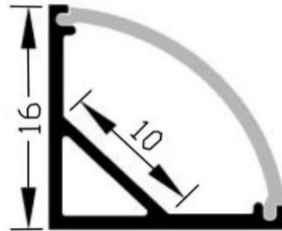

B



INDEX



Długość
délka, dĺžka, length



	INDEX	ABC		Długość délka, dĺžka, length		
A	012525	Basic	Srebrny Stieborná stříbrná silver	1m	Aluminium anodowane / hliník eloxovaný / hliník eloxovaný/ anodized aluminum	5902216796133
	012526	Basic		2m		5902216796140
B	012530	Basic		1m	Tworzywo sztuczne PC / PC Plast / PC Plast / PC Plastic	5902216796232
	012529	Basic		2m		5902216796249

Dostępne akcesoria:



012543 Zaślepka profil narożny Basic



012554 Zaślepka profil narożny Basic z otworem



BroLux

PROFIL BASIC



PROFIL NAWIERZCHNIOWY ŚREDNI SREBRNY

CZ: profil střední průměr stříbra / SK: profil priemernú povrchovú striebro / EN: profile average surface silver



INDEX



Długość
délka, dĺžka, length



A	012518	Basic	Srebrny Stieborná stříbrná silver	2m	Aluminium anodowane / hliník eloxovaný / hliník eloxovaný / anodized aluminum	5902216796164
B	012540	Basic		2m	Tworzywo sztuczne PC / PC Plast / PC Plast / PC Plastic	5902216796256

Dostępne akcesoria:



012532 Zaślepka profil
nawierzchniowy średni Basic



012533 Zaślepka profil
nawierzchniowy średni Basic
z otworem



012531 Uchwyt
montażowy profil Basic



Br^olux

www.bowi.com.pl

PROFIL BASIC



PROFIL WPUSZCZANY ŚREDNI SREBRNY

CZ: zlepšený střední stříbrný profil / SK: zlepšený stredný strieborný profil / EN: improved medium silver profile

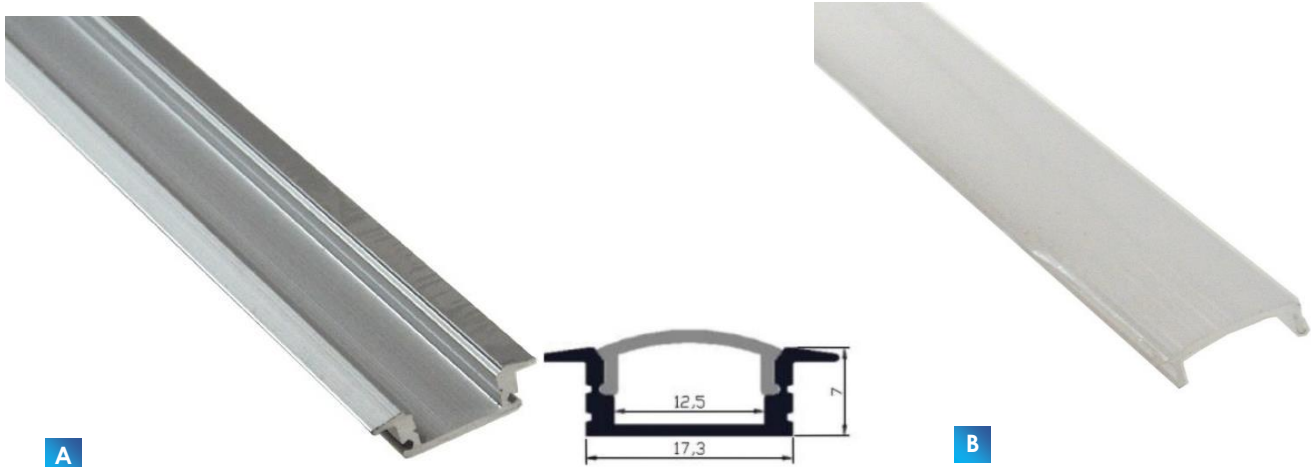

A

B



INDEX



Długość
délka, dĺžka, length



	INDEX	ABC	Material	Length	Description	Barcode
A	012524	Basic	Srebrny Stieborná stříbrná silver	2m	Aluminium anodowane / hliník eloxovaný / hliník eloxovaný / anodized aluminum	5902216796201
B	012540	Basic	Srebrny Stieborná stříbrná silver	2m	Tworzywo sztuczne PC / PC Plast / PC Plast / PC Plastic	5902216796256

Dostępne akcesoria:



012527 Zaślepka profil
wpuszczany średni Basic



012544 Zaślepka profil
wpuszczany średni Basic
z otworem



012531 Uchwyt
montażowy profil Basic



BroLux

www.bowi.com.pl

PROFIL PRIMAL



PROFIL NAWIERZCHNIOWY ŚREDNI SREBRNY

CZ: profil střední průměr stříbra / SK: profil priemernú povrchovú striebro / EN: profile average surface silver



INDEX



Długość
délka, dĺžka, length



A	012523	Primal	Srebrny Stieborná stříbrná silver	1m	Aluminium anodowane / hliník eloxování / hliník eloxovaný/ anodized aluminum	5902216796195
	013079	Primal		2m		5902216799639
B	012541	Primal		1m	Tworzywo sztuczne PC / PC Plast / PC Plast / PC Plastic	5902216796263
	013081	Primal		2m		5902216799653

Dostępne akcesoria:



013083 Zaślepka profil
nawierzchniowy średni Primal



013084 Zaślepka profil
nawierzchniowy średni
Primal z otworem



013082 Uchwyt
montażowy profil Primal



Br^olux

www.bowi.com.pl

PROFIL PRIMAL



PROFIL NAWIERZCHNIOWY WYSOKI SREBRNY

CZ: vysoký profil povrchu stříbrné / SK: vysoký povrchový strieborný profil / EN: high surface silver profile



	INDEX	ABC		Długość délka, dĺžka, length		
A	012519	Primal	Srebrny Stieborná stříbrná silver	1m	Aluminium anodowane / hliník eloxování / hliník eloxovaný/ anodized aluminum	5902216796171
	012520	Primal		2m		5902216796188
B	012541	Primal		1m	Tworzywo sztuczne PC / PC Plast / PC Plast / PC Plastic	5902216796263
	013081	Primal		2m		5902216799653

Dostępne akcesoria:



012542 Zaślepka profil
nawierzchniowy wysoki Primal



012552 Zaślepka profil
nawierzchniowy wysoki
Primal z otworem



013082 Uchwyt
montażowy profil Primal



BroLux

PROFIL PRIMAL



PROFIL WPUSZCZANY WYSOKI SREBRNY

CZ: vylepšený vysoký stříbrný profil / SK vylepšený vysoký profil striebra / EN: improved high silver profile

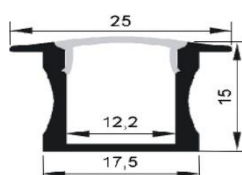

A

B



INDEX



Długość
délka, dĺžka, length



A	012521	Primal	Srebrny Stieborná stříbrná silver	1m	Aluminium anodowane / hliník eloxovaný / hliník eloxovaný / anodized aluminum	5902216796218
	012522	Primal		2m		5902216796225
B	012541	Primal		1m	Tworzywo sztuczne PC / PC Plast / PC Plast / PC Plastic	5902216796263
	013081	Primal		2m		5902216799653

Dostępne akcesoria:



012528 Zaślepka profil
wpuszczany wysoki Primal



012553 Zaślepka profil
wpuszczany wysoki Primal z
otworem



012531 Uchwyt
montażowy profil Primal



BroLux

PROFIL PRIMAL



PROFIL WPUSZCZANY ŚREDNI SREBRNY

CZ: zlepšený střední stříbrný profil / SK: zlepšený stredný strieborný profil / EN: improved medium silver profile



A

B



INDEX



Długość
délka, dĺžka, length



	INDEX	ABC		Długość délka, dĺžka, length		
A	012523	Primal	Srebrny Stieborná stříbrná silver	1m	Aluminium anodowane / hliník eloxování / hliník eloxovaný/ anodized aluminum	5902216796195
	013080	Primal		2m		5902216799646
B	012541	Primal		1m	Tworzywo sztuczne PC / PC Plast / PC Plast / PC Plastic	5902216796263
	013081	Primal		2m		5902216799653

Dostępne akcesoria:



012527 Zaślepka profil
wpuszczany średni Primal



012544 Zaślepka profil
wpuszczany średni Primal
z otworem



012531 Uchwyt
montażowy profil Primal



BroLux

www.bowi.com.pl

CZUJNIKI ZMIERZCHOWE

CZ: snímač soumraku/ SK: snímač súmraku/ EN: twilight sensor



	INDEX	Max. load		Light level	IP			
							L x W x H	
A	011587	300W	AC 230V	5-15Lux	IP20	Biały	125 x 78.8mm	5902216786578
B	011584	400W	AC 230V	5-50Lux	IP44	biła	82x125 mm	5902216786585
C	221	300W	AC 230V	5-50Lux	IP54	Bielá	56.8x37.3x24mm	5902216786615
D	222	300W	AC 230V	2-100Lux	IP65	white	90x66x35mm	5902216786622
E	6747	300W	AC 230V	2-100Lux	IP65	Szary	63.4x48x27.3mm	5902216786608
						Šedá		
						Šedý		
						Grey		

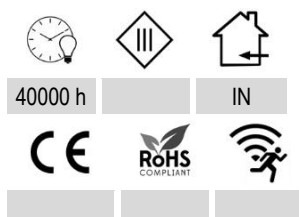

Materiał / Materiál / Material

PL: Tworzywo sztuczne PC

CZ: PC Plast

SK: PC Plast

EN: PC Plastic

Optymalne warunki eksploatacji:

Optimální provozní podmínky:

Optimálne prevádzkové podmienky:

Optimal operating conditions:

PL: temperatura.: od -25°C do +60°C

wilgotność: <85% ciśnienie: 690-1060 hPa

CZ: teplota: od -25°C do +60°C

vlhkost: <85% tlak: 690-1060 hPa

SK: teplota: od -25°C do +60°C

vlhkost: <85% tlak: 690-1060 hPa

EN: temperature: from -25°C to +60°C

humidity: <85% pressure: 690-1060 hPa

Uwagi / Komentář / Komentáre

PL: Kąt działania czujnika 360°

CZ: Rozsah čidla pohybu 360°

SK: Uholi činnosti pohybového čidla 360°

EN: Sensor angle 360°

0-10 V



CZUJNIKI ŚWIATŁA OTOCZENIA

CZ: snímač okolního světla / SK: snímač okolitého svetla / EN: ambient light sensor



INDEX	Oświetlenie	IP		Ø x H	
7170	50-800Lux	IP20	Biały biła Bielá white	Ø69*38mm	5902216786592



40000 h



IN



Materiał / Materiál / Material

PL: Tworzywo sztuczne PC

CZ: PC Plast

SK: PC Plast

EN: PC Plastic

Optymalne warunki eksploatacji:

Optimální provozní podmínky:

Optimálne prevádzkové podmienky:

Optimal operating conditions:

PL: temperatura.: od -25°C do +60°C

wilgotność: <85% ciśnienie: 690-1060 hPa

CZ: teplota: od -25°C do +60°C

vlhkost: <85% tlak: 690-1060 hPa

SK: teplota: od -25°C do +60°C

vlhkost: <85% tlak: 690-1060 hPa

EN: temperature: from -25°C do +60°C

humidity: <85% pressure: 690-1060 hPa

Uwagi / Komentář / Komentáre

PL: Kąt działania czujnika 360°

CZ: Rozsah čidla pohybu 360°

SK: Uhol činnosti pohybového čidla 360°

EN: Sensor angle 360°

BroLux

STARLET



OPRAWY AWARYJNE LED

CZ: Nouzové osvětlení LED / SK: núdzové osvetlenie LED / EN: Emergency lighting LED



A



B

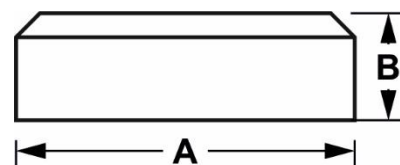

INDEX



Tc[K]



Rodzaj soczewki

Tryb pracy

Test

Czas pracy

A

B



	INDEX	ABC	Power plug	Light bulb	Tc[K]	Light beam	Rodzaj soczewki	Tryb pracy	Test	Czas pracy	A [mm]	B [mm]	Barcode
A	012627	Starlet LED	3W	161 lm	5000-6000 K	Biały biela white	Korytarzowa	Awaryjny	Manual	3h	150	44	5901721532540
B	012632	Starlet LED	3W	212 lm	5000-6000 K		Otwarta	Awaryjny	Manual	3h	150	44	5901721532533
A	012629	Starlet LED	3W	161 lm	5000-6000 K		Korytarzowa	Sieciowo-awaryjny	Auto	3h	150	44	5902270316414
A	012628	Starlet LED	3W	212 lm	5000-6000 K		Korytarzowa	Sieciowo-awaryjny	Manual	3h	150	44	5902270316483
B	012633	Starlet LED	3W	212 lm	5000-6000 K		Otwarta	Sieciowo-awaryjny	Manual	3h	150	44	5902270314489
B	012634	Starlet LED	3W	212 lm	5000-6000 K		Otwarta	Sieciowo-awaryjny/awaryjny	Auto	3h	150	44	5902270316421
A	012631	Starlet LED	5W	301 lm	5000-6000 K		Korytarzowa	Sieciowo-awaryjny	Auto	3 h	150	44	5902270316476
B	012636	Starlet LED	5W	360 lm	5000-6000 K		Otwarta	Sieciowo-awaryjny	Auto	3 h	150	44	5902270316452
A	012630	Starlet LED	5W	301 lm	5000-6000 K		Korytarzowa	Sieciowo-awaryjny	Manual	3 h	150	44	5902270315615
B	012635	Starlet LED	5W	360 lm	5000-6000 K		Otwarta	Sieciowo-awaryjny	Manual	3 h	150	44	5902270315486



IP

AC 230V

SMD LED

41



Materiał / Materiál / Materiál

PL: Tworzywo sztuczne PC

CZ: PC Plast

SK: PC Plast

EN: PC Plastic

Uwagi / Komentář / Komentáre

PL: Zasilacz w komplecie

CZ: Napájení je součástí dodávky

SK: Napájanie je súčasťou dodávky

EN: Power supply included

Brolux

www.bowi.com.pl

STARLET



OPRAWY AWARYJNE LED

CZ: Nouzové osvětlení LED / SK: núdzové osvetlenie LED / EN: Emergency lighting LED

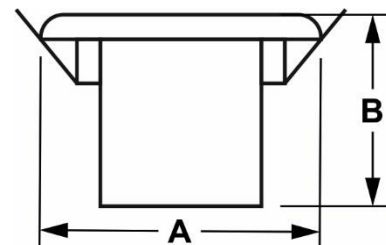

INDEX	ABC					Rodzaj soczewki	Tryb pracy	Test	Czas pracy	A [mm]	B [mm]	
013710	Starlet LED	3W	165 lm	5000-6000 K	Biały bielá white	Korytarzowa	Awaryjny	Auto	3h	85	41,5	5902808805144
012623	Starlet LED	3W	212 lm	5000-6000 K		Otwarta	Awaryjny	Auto	3h	85	41,5	5902270313680
012622	Starlet LED	3W	212 lm	5000-6000 K		Otwarta	Sieciowo-awaryjny	Manual	3h	85	41,5	5903240594184
012625	Starlet LED	5W	360 lm	5000-6000 K		Otwarta	Awaryjny	Auto	3h	85	56,5	5903240594160
012624	Starlet LED	5W	360 lm	5000-6000 K		Otwarta	Sieciowo-awaryjny	Manual	3h	85	56,5	5903240594177

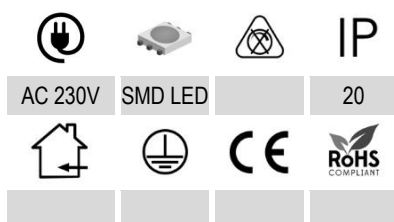

Materiał / Materiál / Materiál

PL: Tworzywo sztuczne PC

CZ: PC Plast

SK: PC Plast

EN: PC Plastic

Uwagi / Komentář / Komentáre

PL: Zasilacz w komplecie

CZ: Napájení je součástí dodávky

SK: Napájanie je súčasťou dodávky

EN: Power supply included



OPRAWY AWARYJNE LED

CZ: Nouzové osvětlení LED / SK: núdzové osvetlenie LED / EN: Emergency lighting LED

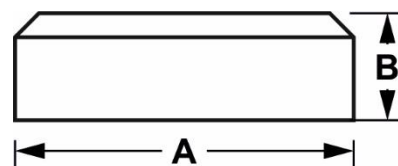

INDEX	ABC			Tc[K]		Rodzaj soczewki	Tryb pracy	Test	Czas pracy	A [mm]	B [mm]	
012644	Owa	1W	142 lm	5000-6000 K	Biały biła Bielá white	Otwarta	Awaryjny	Auto	1h	130	38,5	5902216798519
012645	Owa	1W	142 lm	5000-6000 K		Otwarta	Sieciowo-awaryjny Awaryjny	Manual	1h	130	38,5	5902216798526
012646	Owa	1W	360 lm	5000-6000 K		Otwarta	Awaryjny	Manual	1h	130	38,5	5902216798533
012647	Owa	1W	360 lm	5000-6000 K		Otwarta	Sieciowo-awaryjny Awaryjny	Auto	1h	130	38,5	5902216798540

			IP
AC 230V	SMD LED		20

Materiał / Materiál / Materiál

PL: Tworzywo sztuczne PC

CZ: PC Plast

SK: PC Plast

EN: PC Plastic

Uwagi / Komentář / Komentáre

PL: Zasilacz w komplecie

CZ: Napájení je součástí dodávky

SK: Napájanie je súčasťou dodávky

EN: Power supply included

OPRAWY AWARYJNE LED

CZ: Nouzové osvětlení LED / SK: núdzové osvetlenie LED / EN: Emergency lighting LED

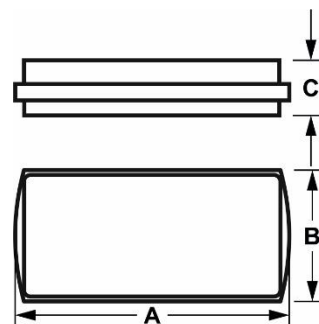

INDEX	ABC					Tryb pracy	Test	Czas pracy	A [mm]	B [mm]	C [mm]	
012616	Orion	3,2W	104 lm	5000-6000 K	Biały biela white	Sieciowo-awaryjny/ Awaryjny	Manual	3h	352	118	73	5901721532168
012617	Orion	3,2W	104 lm	5000-6000 K		Sieciowo-awaryjny/ Awaryjny	Auto	3h	352	118	73	5901721532250
012618	Orion	7W	154 lm	5000-6000 K		Sieciowo-awaryjny/ Awaryjny	Manual	3h	352	110	64	5902270310917
012619	Orion	7W	154 lm	5000-6000 K		Sieciowo-awaryjny/ Awaryjny	Auto	3h	352	110	64	5902270313222

Dostępne Akcesoria:



012637 Tabliczka dwustronna do opraw Orion 3,2W



012638 Tabliczka dwustronna do opraw Orion 7W



012639 Maskownica podtynkowa



AC 230V



SMD LED



IP

65



RoHS COMPLIANT

Materiał / Materiál / Material

PL: Tworzywo sztuczne PC

CZ: PC Plast

SK: PC Plast

EN: PC Plastic

Uwagi / Komentář / Komentáre

PL: Zasilacz w komplecie

CZ: Napájení je součástí dodávky

SK: Napájanie je súčasťou dodávky

EN: Power supply included

OPRAWY AWARYJNE LED

CZ: Nouzové osvětlení LED / SK: núdzové osvetlenie LED / EN: Emergency lighting LED

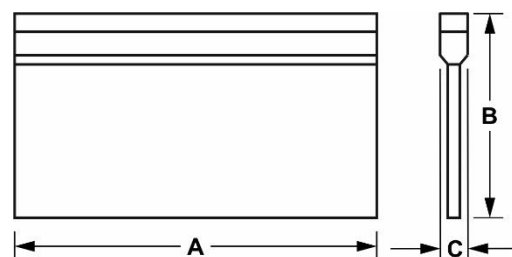

INDEX	ABC		Tc[K]		Tryb pracy	Test	Czas pracy	A [mm]	B [mm]	C [mm]	
012621	Oximia	1W	5000-6000 K	Biały bielá	Sieciowo-awaryjny/ Awaryjny	Auto	3h	335	255	35	5902270314526
012620	Oximia	1W	5000-6000 K	Bielá white	Sieciowo-awaryjny/ Awaryjny	Manual	3h	335	255	35	5903240594177

Dostępne Akcesoria:



012640 Wspornik do montażu ściennego



012641 Wspornik do montażu flagowego



012642 Wspornik do montażu zawieszanego

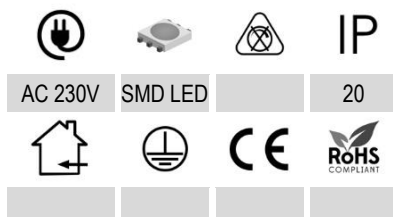

Materiał / Materiál / Materiál

PL: Tworzywo sztuczne PC

CZ: PC Plast

SK: PC Plast

EN: PC Plastic

Uwagi / Komentář / Komentáre

PL: Zasilacz w komplecie

CZ: Napájení je součástí dodávky

SK: Napájanie je súčasťou dodávky

EN: Power supply included



PROFESSIONAL
I M P O R T E R

PHU BOWI
ul. Magazynowa 40
80-180 Jankowo Gdańskie
NIP 5891414986

tel. +48 58 554 83 17

fax. +48 58 554 85 11

info@bowi.com.pl

www.bowi.com.pl